

Glassroof

By Ultraframe

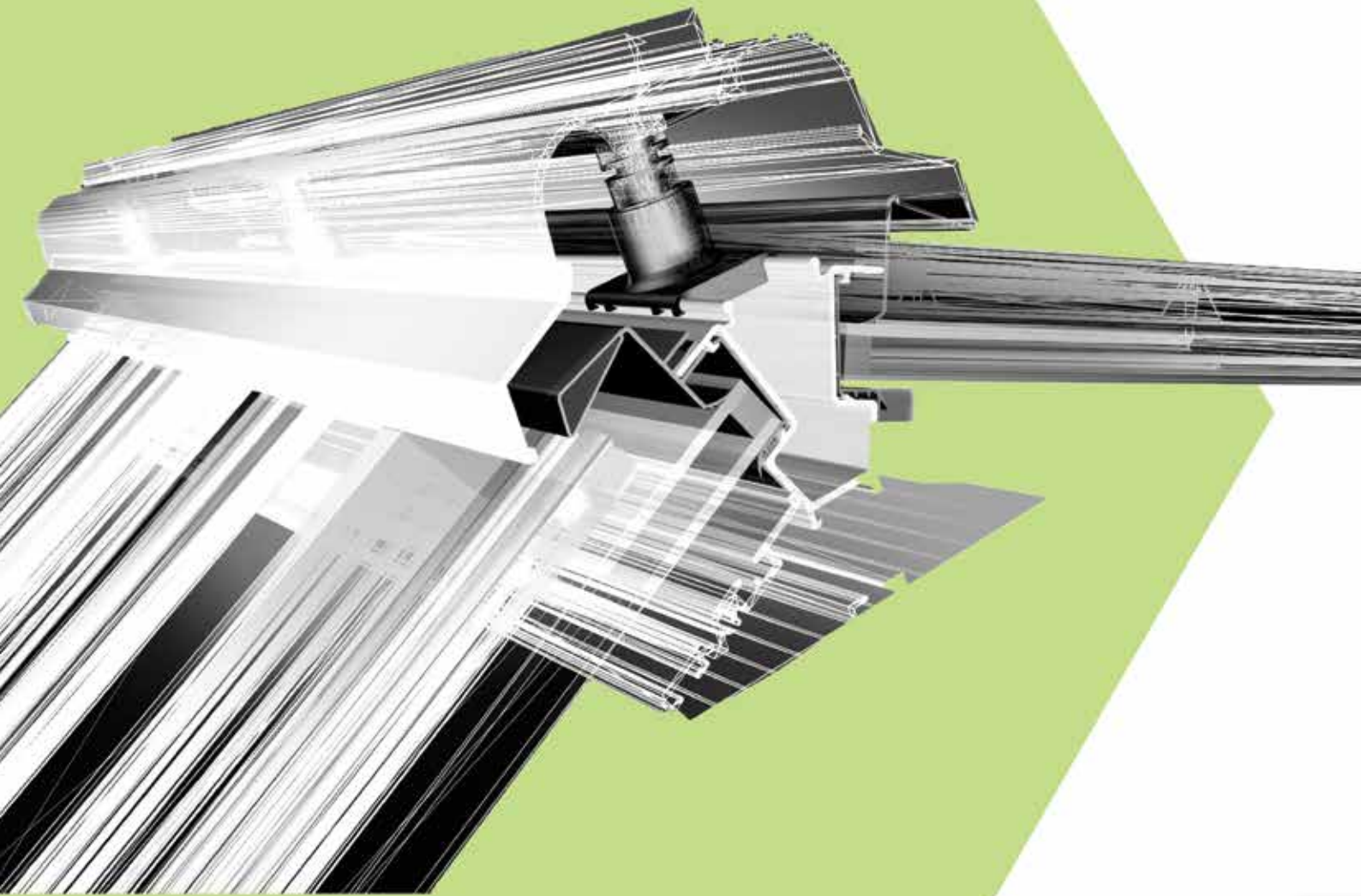

V7 | July 2020

PRODUCT DIRECTORY

DIRECTORY - Overview

This guide is a 'snap shot' of the core elements of the Glass Roof

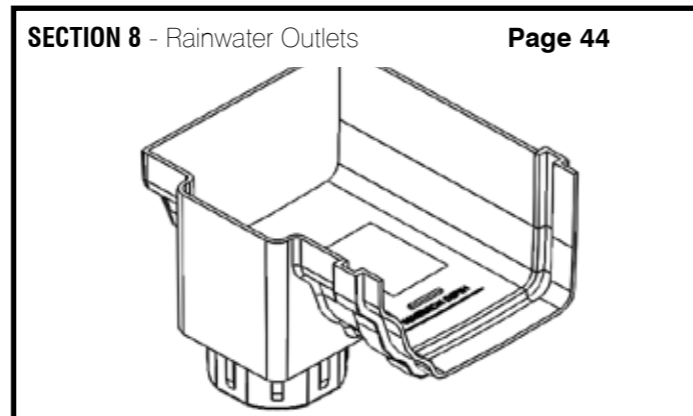
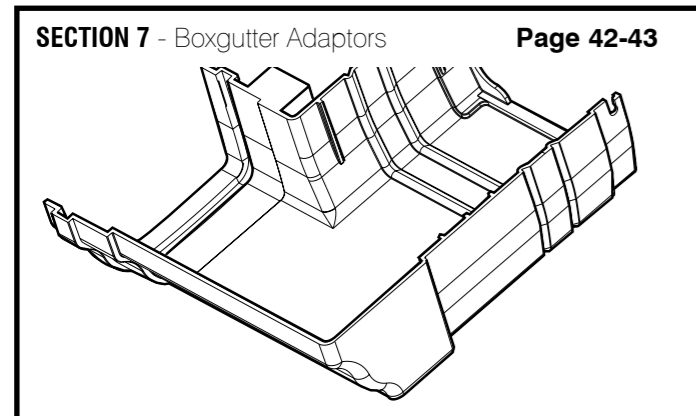
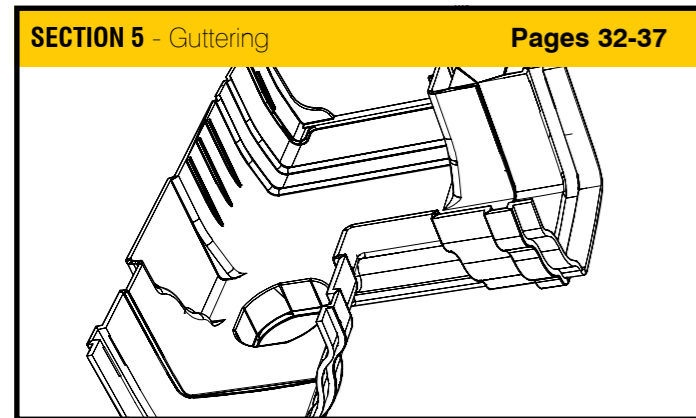
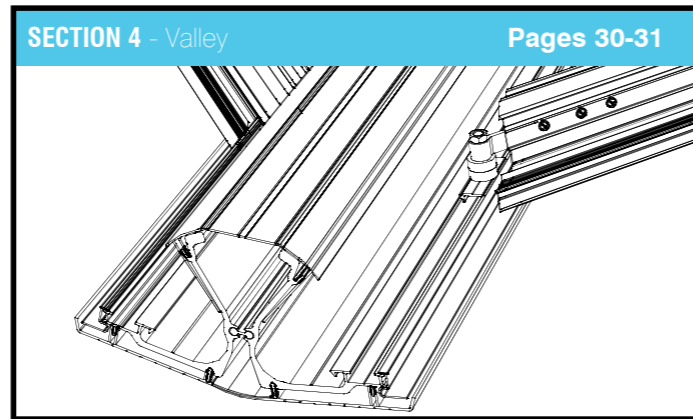
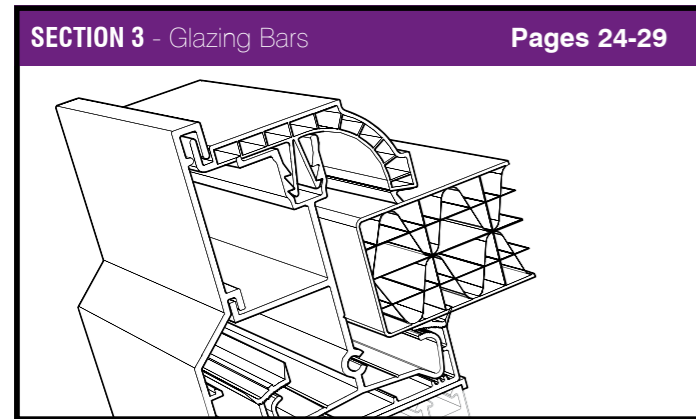
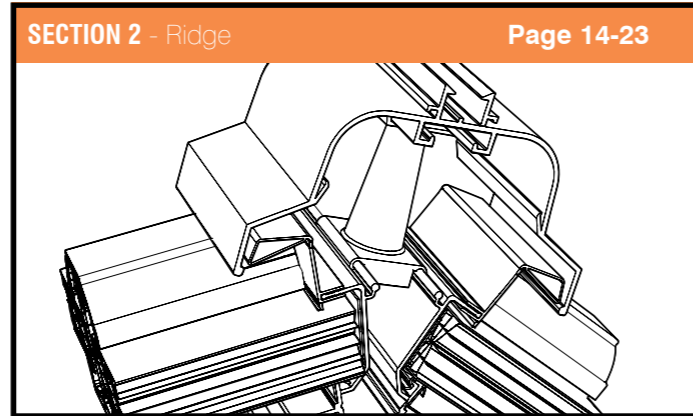
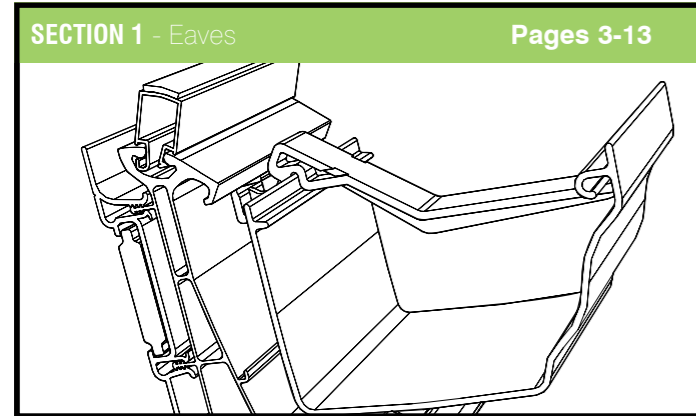

SECTION 1 - Eaves

The starting point for any roof system, as it attaches to the top of the side frames

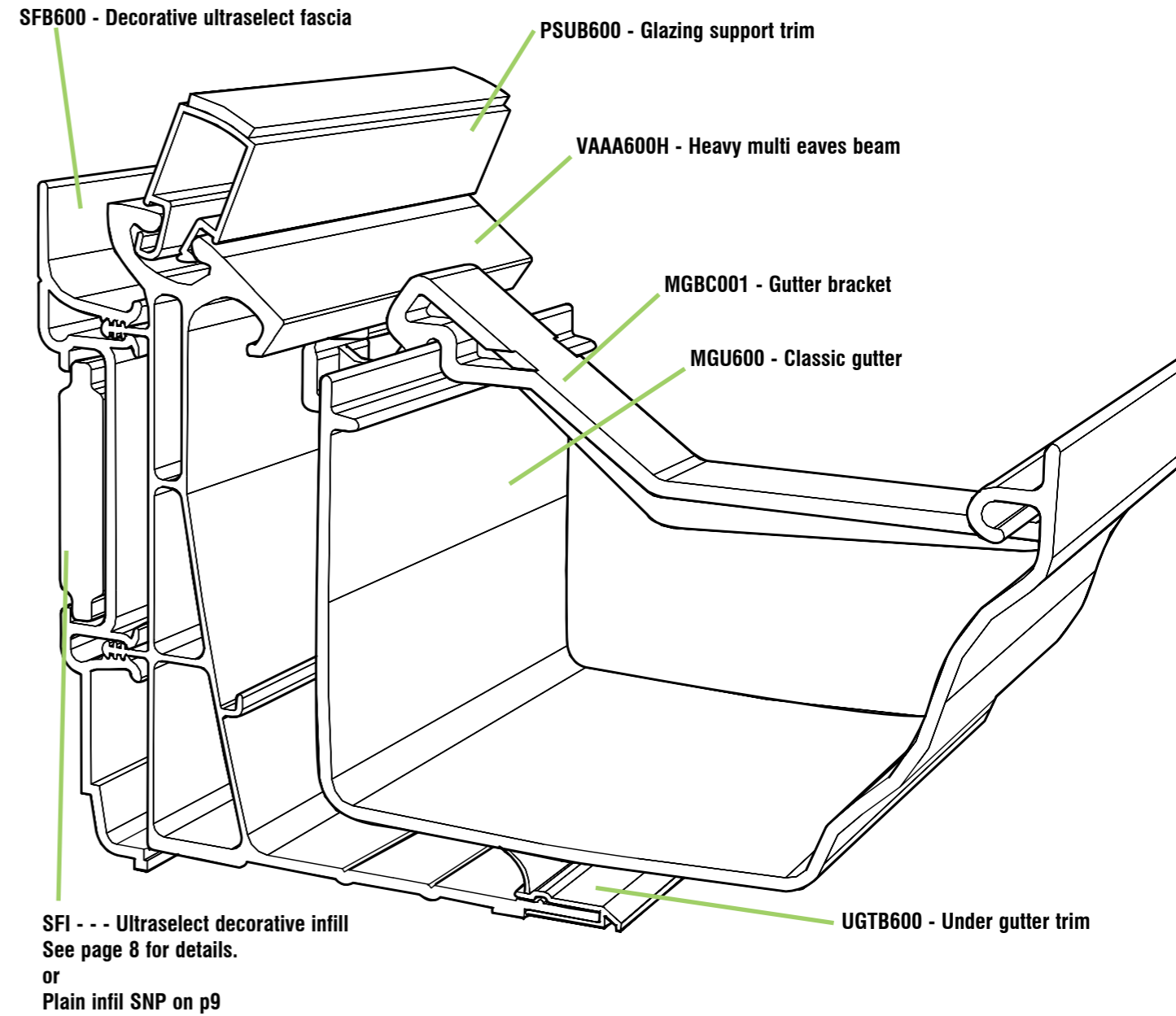

AGP - - - Glazing End Profile

AGP---/25 GLAZING END PROFILE



DTM - - - Dentil Moulding

DTM002 DENTIL MOULDING CLIP FIT
DTM004 DENTIL MOULDING ADHESIVE FIX

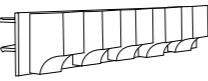

FIR - - - Furring Top Cap (Used with LCTB)

FIR/2NT FIRRING TOP CAP (USED WITH LCTB)



GBR- - - Gable Beam Reinforcement

GBR500 GABLE BEAM REINFORCEMENT 5M
GBR650 GABLE BEAM REINFORCEMENT 6.5M

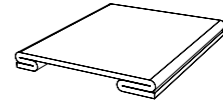

DFCA - - - Decorative Fascia Jointers/ Corners

DFCA001 INLINE JOINTER
DFCA090A ADJUSTABLE CORNER
DFCA090I 90 DEGREE INTERNAL CORNER
DFCA135 135 DEGREE CORNER
DFCA150 150 DEGREE CORNER

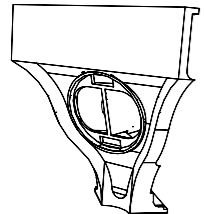

EBCA - - - Eaves Beam Connecting Cleats

EBCA001 CLEAT INLINE
EBCA090 CLEAT 90 DEGREE
EBCA135 CLEAT 135 DEGREE
EBCA150 CLEAT 150 DEGREE

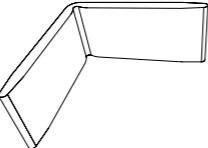

FLN 001 Flange Nut (7mm Holes)

FLN001 FLANGE NUT(7mm HOLES)



GEC - - - Gable Beam Top Cladding

GEC650 GABLE BEAM TOP CLADDING 6.5M

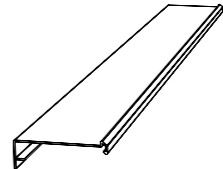

DCM 001 Insert for Decorative Fascia Corners

DCM001 INSERT FOR DEC FASCIA CORNERS

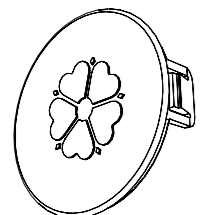

EBT 001 Eaves Beam Cleat Taptite Screw

EBT001 EAVES BEAM CLEAT TAPTITE M5 x12

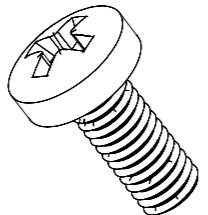

FLNS 001 Spigot Nut (9mm Holes)

FLNS001 SPIGOT NUT (9mm HOLES)



GIE - - - Gable Infill Wedge End Cap

GIE001 GABLE INFILL WEDGE END CAP

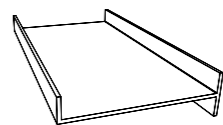

DCM 001 Insert for Decorative Fascia Corners

DCM001/WV INSERT FOR DEC FASCIA CORNERS



EECA - - - Eaves Beam End Plug

EECA001S/L EAVES BEAM END PLUG LEFT
EECA001S/R EAVES BEAM END PLUG RIGHT

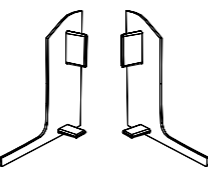

GAC 001 Gable Eaves Beam Corner

GAC001L CORNER LEFT(BOLT SLOT RETURN)
GAC001R CORNER RIGHT(BOLT SLOT RETURN)

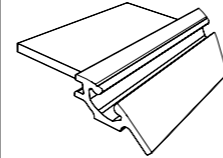

LCP - - - Low Pitch Lean to Eaves End Cap Block

LCP001L LOW PITCH LEAN TO EAVES END CAP BLOCK LEFT
LCP001R LOW PITCH LEAN TO EAVES END CAP BLOCK RIGHT

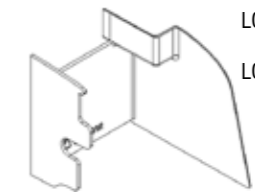

DFS 650/2 Trim to Front of Super Duty Eaves Beam

DFS650/2 TRIM TO FRONT OF SUPER DUTY EAVES BEAM



EFSA 021 End Cap Fixing Kit (20)

EFSA 021 END CAP FIXING KIT (20)

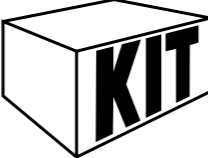

GBE - - - Aluminium Gable Beam

GBE400 ALUMINIUM GABLE BEAM 4M
GBE650 ALUMINIUM GABLE BEAM 6.5M

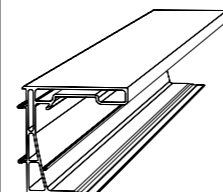

LHEA - - - Lantern Header Beam

LHEA600 LANTERN HEADER BEAM
LHEA600_/1 LANTERN INTERNAL FASCIA TRIM
LHEA600_/2 LANTERN EXTERNAL FASCIA TRIM



DTA - - - Dentil add on Profile

DTA600 DENTIL ADD ON 58-64MM FRAMES
DTA600L DENTIL ADD ON 65-70MM FRAMES

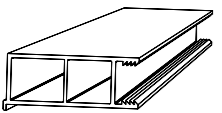

ETV 001 Eaves Ventilator

ETV001 EAVES VENTILATOR



GBIA - - - Gable Infill Wedge

GBIA010 GABLE INFILL WEDGE - 10°
GBIA0125 GABLE INFILL WEDGE - 12.5°
GBIA015 GABLE INFILL WEDGE - 15°
GBIA020 GABLE INFILL WEDGE - 20°
GBIA025 GABLE INFILL WEDGE - 25°
GBIA030 GABLE INFILL WEDGE - 30°
GBIA035 GABLE INFILL WEDGE - 35°
GBIA040 GABLE INFILL WEDGE - 40°

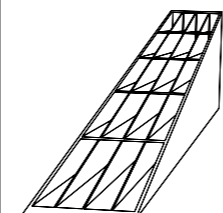

PCF - - - Glazing End Profile Trim

PCFD/24 END PROFILE TRIM (24MM)
PCFD/35 END PROFILE TRIM (35MM)



PFCA - - - V Groove Fascia Jointers/Corners

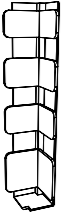

PFCA001	JOINT INLINE
PFCA090E	90 DEG EXTERNAL
PFCA290V	90 DEG INTERNAL CORNER
PFCB135V	135 DEG INTERNAL CORNER
PFCA150	150 DEG INTERNAL CORNER

PFTC - - - V Groove fascia

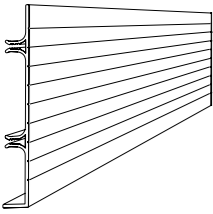

PFTC600V	FASCIA CLADDING 6M
----------	--------------------

PST - - - Glazing Support Trim (Punched)



PST003	TRIM 1600MM PUNCHED
PST004	TRIM 950MM PUNCHED

(USED IN CONJUNCTION WITH ETV001)

PSUB - - - Glazing Support Trim

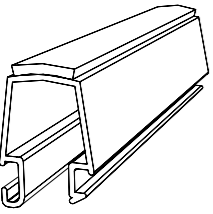

PSUB600	SUPPORT TRIM 6M
---------	-----------------

RES 001 Gable Eaves Corner Screw

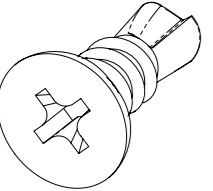

RES001	GABLE EAV CORNER SCREW 3.9 X 16 (C/SK HEAD SELD DRILL SCREW)
--------	--

(ALSO USED FOR SECURING REINFORCING IN GABLE HEAD)

RS3510 M6 x 20mm Bolt for Low Pitch Eaves

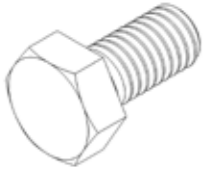

RS3510	M6 x 20mm Bolt for Low Pitch Eaves ONLY
--------	---

SAB 001 Anchor Bolt - Used on TBRK

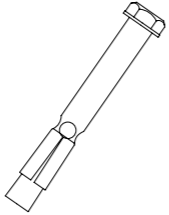

SAB001	BOX GUTTER BOLT M8 X 80MM
SAB002	BOX GUTTER BOLT M6 X 65MM

SEBA 600/1 Structural Eaves Beam



SEBA600/1	STRUCTURAL EAVES BEAM 6M
-----------	--------------------------

SEB 001 Splice Plate - Structural Eaves Beam

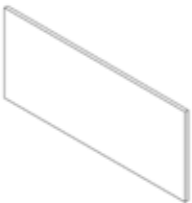

SEB001	SPLICE PLATE- STRUCTURAL EAVES BEAM
--------	-------------------------------------

SEB 002 Eaves End Cap



SEB002L	EAVES END CAP LEFT
SEB002R	EAVES END CAP RIGHT

SEB 003 Fascia Inline Joint



SEB003L	FASCIA INLINE JOINT LEFT
SEB003R	FASCIA INLINE JOINT RIGHT

(FASCIA TO BOX GUTTER)

SES 001 90° Butterfly Strap (TBRK)

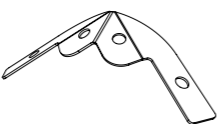

SES001	90° BUTTERFLY STRAP
--------	---------------------

SEB550 - -/3 Bolster Male Cladding



SEB550--/3	BOLSTER MALE CLADDING
------------	-----------------------

(SITS UNDER SUPER DUTY EAVES BEAM)

SES 002 Inline Cleat (TBRK)

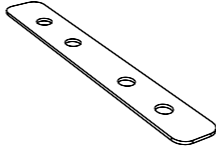

SES002	INLINE CLEAT
--------	--------------

SES 003 Inline Cleat (with transom) (TBRK)

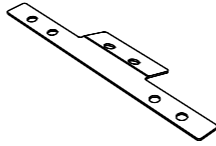

SES003	INLINE CLEAT (WITH TRANSOM)
--------	-----------------------------

SES 004 135° Butterfly Strap (TBRK)

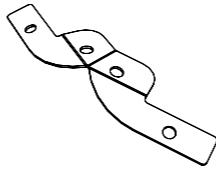

SES004	135° BUTTERFLY STRAP
--------	----------------------

SES 005 165 Box Gutter Strap (TBRK)

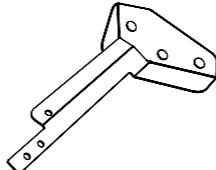

SES005L	LEFT HAND BRACKET
SES005R	RIGHT HAND BRACKET

SES 006 265 Box Gutter Strap (TBRK)

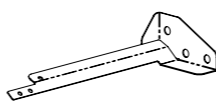

SES006L	LEFT HAND BRACKET
SES006R	RIGHT HAND BRACKET

SEWC 001 Aluminium Eaves Moulding (TBRK)

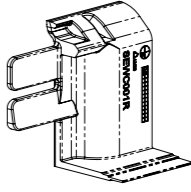

SEWC001L	LEFT HAND EAVES WALL CLEAT
SEWC001R	RIGHT HAND EAVES WALL CLEAT (Pictured)

SFB - - - Decorative Ultraselect Fascia

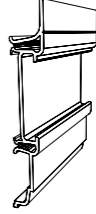

SFB600	DEC SELECT FASCIA BOARD
--------	-------------------------

SFI - - - Decorative Ultraselect Infills



SFI003 - Tapestry	SFI003K	SFI003G
-------------------	---------	---------

SFS 001 M6 X 16 TapTite- Splice Plate



SFS001	M6 x 16 TAPTITE- SPLICE PLATE
--------	-------------------------------

SHBC - - - Glazing Bar Fixing Bolts



SHBC001S	SINGLE BOLT 21.5mm LONG
SHBC001SL	SINGLE BOLT 30mm LONG
SHBC001T	TWIN BOLT ASSEMBLY 21.5mm LONG
SHBC050S	SINGLE BOLT 21.5 & NUT (BAG OF 50)

SNP - - - Decorative Ultraselect Plain Fascia Infill



SNP600	DEC FASCIA PLAIN INFIL
--------	------------------------

TBW 002 Washer Used with SHBC001SL

TBW002 WASHER
(USED WITH SHBC001SL)



UZRI 010 Eaves Moulding Fixing (TBRK)

UZRI010/5 EAVES MOULDING STARTER FIXING
M8 SINGLE COILED SPRING

(USE WITH VRK004/1)

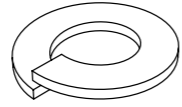

UGTB - - - Under Gutter Trim

UGTB600 UNDER GUTTER TRIM 6M

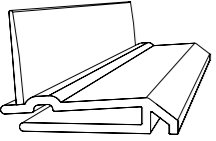

VAAA600H Eaves Beam

VAAA600H MULTI EAVES BEAM 6M

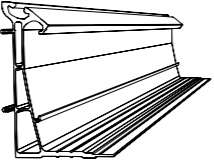

UZBGF 001 Butterfly Cleat Screw (TBRK)

UZBGF001 BUTTERFLY CLEAT SCREW 6 X 16

(ALSO USED FOR INLINE CLEATS OR BOX GUTTER STRAPS)

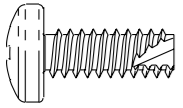

VFK - - - Victorian Fixing Kit

VFK001 VICTORIAN FIXING KIT
17 x Small(22mm) & 3 x Large(37mm)

VFK002 VICTORIAN FIXING KIT
20 x Large(37mm)

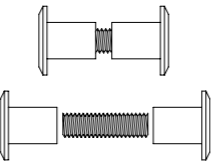

UZLPEB/ - Low Pitch Eaves Beam

UZLPEB/1 LOW PITCH EAVES BEAM
UZLPEB/2 EAVES INNER BOTTOM TRIM
UZLPEB/3 EAVES EXTERNAL CLADDING
UZLPEB/4 INTERNAL FASCIA CLADDING



VLPB 001/1 Eaves Beam high and Low Pitch Packer

VLPB001 TRANSOM BAR PACKER (BLACK)

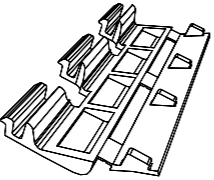

UZLPEJ001 Sleeve to Join Inline Low Pitch Eaves Beam

UZLPE001 SLEEVE TO JOIN INLINE EAVES



VRK 004/1 Eaves Moulding Starter Fixing (TBRK)

VRK004/1 EAVES MOULDING STARTER FIXING
M8 X 35 BOLT AND NUT

(USE WITH UZRI 010)

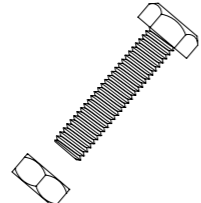

UZLPFR/1

UZLPFR/1 FIRRING MAIN BODY



UZLPFR/2

UZLPFR/2 FIRRING BASE (SITS ON FRAME)



UZLPFR/4

UZLPFR/4 FIRRING TRIM

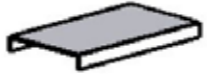

UZLPFR/6

UZLPFR/6 STEEL REINFORCEMENT



UZLPFR/5

UZLPFR/5 ALUMINIUM REINFORCEMENT



SECTION 1.1 - Cornice

CRN---/1 Lower Cornice Section

CRN---/1 LOWER CORNICE SECTION
(USED WITH STANDARD EAVES BEAM)



CRN---/4 SEB Cornice Trim

CRN---/4 SEB Cornice Trim



CRN---/2 Middle Cornice Section

CRN---/2 MIDDLE CORNICE SECTION



CRN---/5 External Cornice Extension

CRN---/5 EXTERNAL CORNICE EXTENSION



CRN---/3 Upper Cornice Section

CRN---/3 UPPER CORNICE SECTION



CRN001 Cleat

CRN001 CLEAT (CONNECTING CORNICE CORNERS)



CRN002 Support Bracket

CRN002 SUPPORT BRACKET - CORNICE GUTTER



CRN003 Gable/Lean To End Plate

CRN003 GABLE/LEAN TO END PLATE - CORNICE



CRN00- TIE WIRE

CRN005 TIE WIRE (USED OFF TRANSOM JACK)
CRN012 CORNICE CORNER TIE WIRE



CRN006 Cleat Screw M4 X 10

CRN006 CLEAT SCREW M4 X 10



CRN007 Section Screw 4.8 X 16

CRN007 SECTION SCREW 4.8 X 16



CRN008 End Plate Screw 3.5 X 13

CRN008 END PLATE SCREW 3.5 X 13



CRN010 Tie Wire Screw

CRN010 TIE WIRE SCREW



CRN014 Cornice Inline Outlet Cover

CRN014 CORNICE INLINE OUTLET COVER



CRN090 90° Cornice Corner Covers

CRN090 90° CORNICE CORNER COVERS



CRN135 135° Cornice Corner Covers

CRN135 135° CORNICE CORNER COVERS



CRN180 180° Cornice Corner Covers

CRN180 180° CORNICE CORNER COVERS



LANC002 Cornice Lower Infill

LANC002 CORNICE LOWER INFILL



LANCF001 4.2 x 19 Pozi Pan Head Screw

LANCF001 4.2 X 19 S/DRILL POZI PAN HEAD SCREW A2ST



LANCL001 Cornice Inline Extension 3 Tier

LANCL001 CORNICE INLINE EXTENTION 3 TIER



LANCL003 Flat Cornice Endplate 3 Tier

LANCL003 FLAT CORNICE ENDPLATE 3 TIER



LANCL014 Cornice Inline O/L Cover 3 Tier

LANCL014 CORNICE INLINE O/L COVER 3 TIER

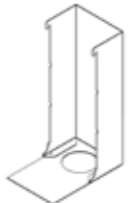

LANCL090 Cornice Corner Extension 3 Tier

LANCL090 CORNICE CORNER EXTENSION 3 TIER



LANCS001 Cornice Inline Extension 2 Tier

LANCS001 CORNICE INLINE EXTENSION 2 TIER



LANCS003 Lean-To/Gable End Plate (2 Tier)

LANCS003 LEAN-TO/GABLE END PLATE (2 TIER)



LANCS014 Cornice Inline O/L Cover 2 Tier

LANCS014 CORNICE INLINE O/L COVER 2 TIER



LANCS090 Cornice Corner Extension 2 Teir

LANCS090 CORNICE CORNER EXTENSION 2 TEIR



LPC001 Prestige Cornice Inline Jointer

LPC001 PRESTIGE CORNICE INLINE JOINTER



LPCD - - - Cornice Sealing Dam

LPCD001 CORNICE SEALING DAM (JOINT/ENT)
LPCD090 CORNICE SEALING DAM (MITRED JOINT)



LPCG015 Cornice Eaves Sealing Foam

LPCG015 CORNICE EAVES SEALING FOAM

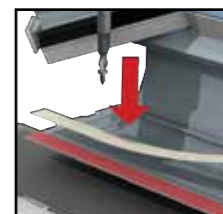

LPCL090 Prestige Cornice Corner 90° Large Column

LPCL090 PRESTIGE CORNICE CORNER 90° LARGE COLUMN



SCN - - - Lower Cornice Section

SCN Lower Cornice Section (USED WITH SUPER DUTY EAVES BEAM)



LPCP001 Lean-To/Gable End Plate (1 Tier)

LPCP001 LEAN-TO/GABLE END PLATE (1 TIER)



LPCP002 Cornice Inline O/L Cover 1 Tier

LPCP002 CORNICE INLINE O/L COVER 1 TIER



LPCS090 Prestige Cornice Corner 90° Small Column

LPCS090 PRESTIGE CORNICE CORNER 90° SMALL COLUMN



LPR021 Cornice Corner 90° Large Column

LPR021 CORNICE CORNER 90° LARGE COLUMN



LPR022 Cornice Corner 90° Small Column

LPR022 CORNICE CORNER 90° SMALL COLUMN



SECTION 2 - Ridge

The ridge takes the initial structural loads and is the lynch pin of the roof system

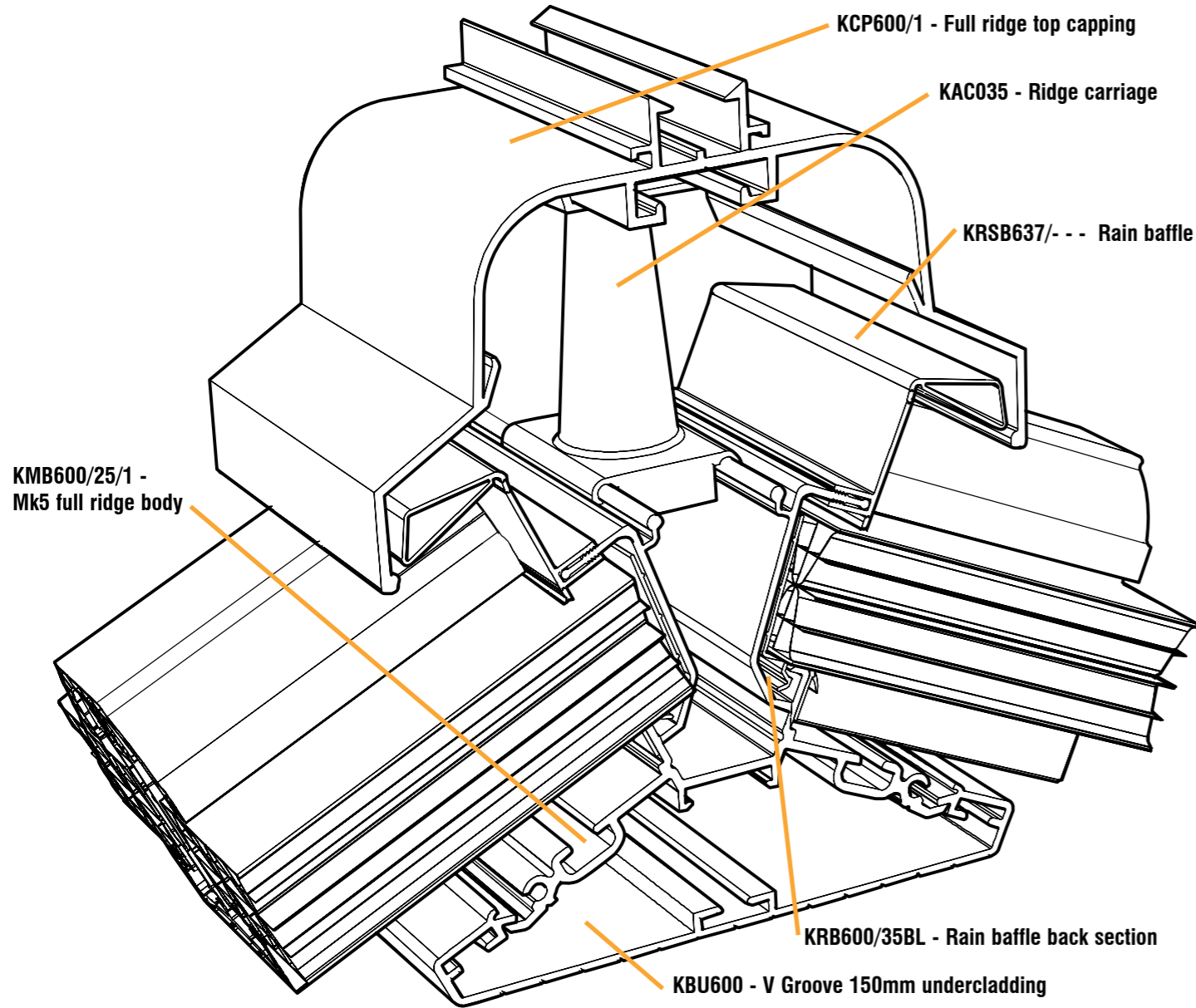

ACC 001 Aluminium Cresting Finial Adaptor

ACC001 FINIAL ADAPTOR

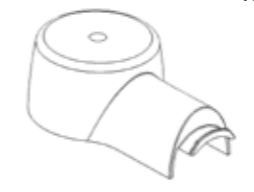

ACC 002 Aluminium Finial Adaptor Fixing

ACC002 FINIAL ADAPTOR FIXING



ACC 050 Aluminium Cresting

ACC050 ALUMINIUM CRESTINGS



ACF 001 Ball Finial - Aluminium

ACF001 BALL FINIAL



ACP ---/1 Aluminium Ridge Cap

ACP---/1 RIDGE TOP CAP

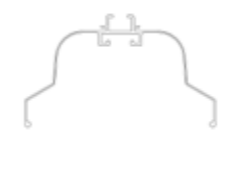

ACP 001 Aluminium Ridge Cap

ACP001 EXTERNAL RADIUS END COVER

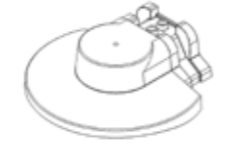

ACP 002 BRUSH- EXT RADIUS END

ACP002 BRUSH- EXT RADIUS END



ACP 003 RADIUS END CLAMP WASHER

ACP003 RADIUS END CLAMP WASHER



ACP 004 RADIUS END FLASHING TRIM

ACP004 RADIUS END FLASHING TRIM



AHC ---/1 Aluminium Half Ridge

AHC---/1 HALF RIDGE TOP CAP



AHC - - - Aluminium Half Ridge

AHC001L HALF RIDGE RADIUS END COVER-LEFT
AHC001R HALF RIDGE RADIUS END COVER-RIGHT

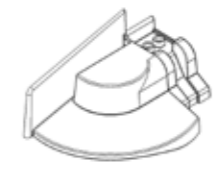

AHC 002 Half Ridge Radius End Cover

AHC002 BRUSH - HALF RIDGE RADIUS END COVER



ANFC - - - **Ball Finial**



ANFC002 WOK BALL
ANFC004 PVC BALL

ALC---/1 **Lean-to Cloaking Trim**



ALC---/1 LEAN-TO CLOAKING TRIM

ALP - - - **Low Profile Cresting - Aluminium**



ALP---/1 LOW PROFILE CRESTING

BFNA 004 **Sceptre Finial**

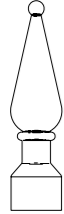

BFNA004 SCEPTRE MOULDED FINAL

CCE 050 **Renaissance Cresting**



CCE050 RENAISSANCE CRESTING 500MM (EASY CLEAN, CLIP OVER)
CCE100/1 RENAISSANCE ADAPTOR (ABUTS FINIAL)

CNL 050 **Baroque Cresting**



CNL050 BAROQUE CREST 500MM

CPP 050 **Elizabethan Cresting**



CPP050 ELIZABETHAN CREST 500MM

CRC 090 **External (270 deg) Radius End Cover**



CRC090 EXTERNAL (270 DEG) RADIUS END COVER L-SHAPE HALF RIDGE

CRE 050 **Classic Cresting**

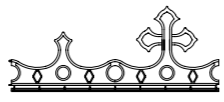

CRE050 CLASSIC CREST 500MM

CRU 090 **Internal (270 deg) Radius End Cover**



CRU090 INTERNAL (270 DEG) RADIUS END COVER L-SHAPE HALF RIDGE

CSL 050 **Tudor Cresting**



CSL050 TUDOR CREST 500MM

CUD - - - **Low profile Cresting**

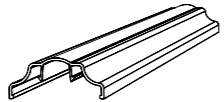

CUD600 LOW PROFILE CRESTING 6M

DPA - - - **Differential Pitch- Ridge Adaptor**



DPA001 DIFFERENTIAL PITCH- RIDGE ADAPTOR
DPA002 DIFFERENTIAL PITCH- RIDGE SPACER BUSH

FIN - - - **Classic Finial**



FIN004 CLASSIC FINIAL
FIN001L CLASSIC FINIAL (TO SUIT WOK)

FLY - - - **Flymesh Strip**



FLY620-24 FLYMESH STRIP - FULL RIDGE 24MM 6.2M
See UWC600/1 FOR HALF RIDGE FLYMESH

FUDA 001 **Low Profile Finial**

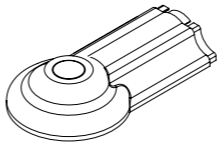

FUDA001 LOW PROFILE FINIAL

FWE 001 **Full Wok External Capping**

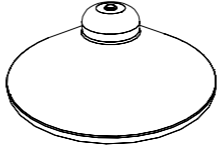

FWE001/1 FULL WOK EXTERNAL CAPPING
(VBC143 BRUSH CLIP 1430MM LG WHITE)
(VBLA143/1 RAD END BRUSH 7 SERIES 1430MM)
(ALSO NEED TFR200)
(SPECIAL CIRCUMSTANCES - NOT STANDARD)

FWIA 001 **Full Wok Internal Capping**

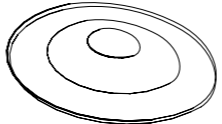

FWIA001 FULL WOK INTERNAL CAPPING
(ALSO NEED TFR200)
(SPECIAL CIRCUMSTANCES - NOT STANDARD)

QGBC - - - **Wallplate Internal Cladding**

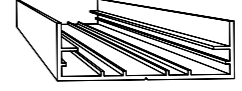

QGBC600W INT CLADDING 6M (PWLA)

HCG - - - **Half Wok External Capping - Georgian**



HCG003 15-20° GEORGIAN HALF WOK CAP INC CLIPS
HCG004 25-30° GEORGIAN HALF WOK CAP INC CLIPS
VBLA080/1 RAD END BRUSH 7 SERIES BAR 800MM GEORGIAN

HCV - - - **Half Wok External Capping - Victorian**



HCV003 15-20° VICTORIAN HALF WOK CAP INC CLIPS
HCV004 25-30° VICTORIAN HALF WOK CAP INC CLIPS
VBLA069/1 RAD END BRUSH 7 SERIES BAR 690MM VICTORIAN

HRP 001 **Half Ridge Plate**

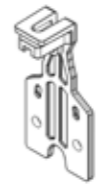

HRP001 HALF RIDGE ADAPTOR SMALL

HRP 002 **Ridge Radius End Support Bracket**

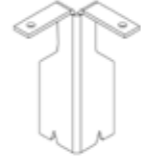

HRP002 RIDGE RADIUS END SUPPORT BRACKET - MAIN PLATE

KAC 035 **Ridge Carriage**

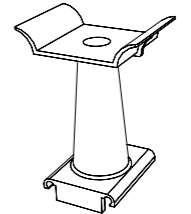

KAC035 RIDGE CARRIAGE

KBC 075 Ridge Cross Brace

KBC075 CROSS BRACE 20 DEG 75MM
KBC075-15 CROSS BRACE 15 DEG 75MM

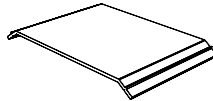

KBC 300 Ridge Joint Plate

KBC300 JOINT PLATE 300MM 20-35 DEG
KBC300-15 JOINT PLATE 300MM 15 DEG

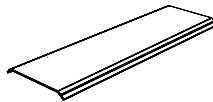

KBEA 001 Radius End Undercladding Ext. Bracket

KBEA001 UNDERCLADDING EXTENSION BRKT



KBF 001 Radius End Undercladding Bracket

KBF001 UNDERCLADDING BRACKET
(INC IN KFKA001 KIT)



KBS 001 Cross Brace Fixing Screw

KBS001 CROSS BRACE SCREW 10 X 3/8
(4.8 X 9.5 SELF DRILLING SCREW)

(ALSO USED TO SECURE STRUCTURAL TOP CARRIAGE - FULL OR HALF RIDGE)

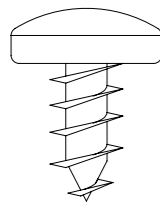

KBU - - - V groove 150mm Undercladding

KBU600 UNDERCLADDING 5.97MM WHI

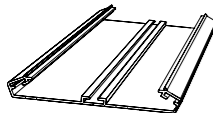

KCG - - - Georgian separate End Capping External

KCG003 15-20DEG GEORG END CAPPING INC CLIPS
KCG004 25-30DEG GEORG END CAPPING INC CLIPS

(ALSO NEED)
VBLA080/1 RAD END BRUSH 7 SERIES BAR
800MM GEORGIAN
SCRA004 STARLOC WASHER

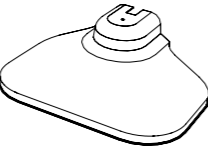

KCP - - - External Ridge Capping

KCP600/1 EXT RIDGE CAPPING SECTION 5.98M

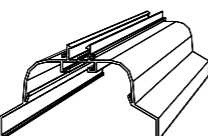

KCS - - - Ridge Top Carriage

KCS060 RIDGE TOP CARRIAGE 60MM (10)
KCS300 RIDGE TOP CARRIAGE 300MM

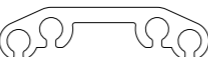

KCT 001/1 Ridge Top Cap Inline Joiner

KCT001/1 RIDGE TOP CAP INLINE JOINER

(RIVETS VSR001 & TAPE BST500A NOT INCLUDED)
*TRIMMED TO SUIT HALF RIDGE INLINE JOINTING

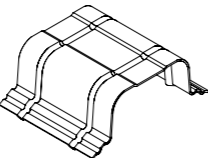

KCV - - - Victorian separate End Capping External

KCV003 15-20 DEG VICTORIAN END CAP INC CLIPS
KCV004 25-30 DEG VICTORIAN END CAP INC CLIPS

(ALSO NEED)
VBLA069/1 RAD END BRUSH 7 SERIES BAR
690MM VICTORIAN
SCRA004 STARLOC WASHER

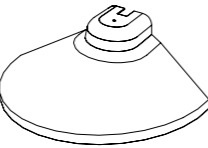

KDS 001 Die Cast End/Ridge Bolster Fixing Screws

KDS001 FULL RIDGE DIE CAST END & TBRK
RIDGE BOLSTER FIXING SCREWS
(4.8 X 25 SELF TAPPING SCREW)

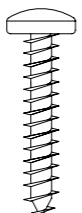

KDS 002 Half Ridge Die Cast End Upper Screw

KDS002 HALF RIDGE DIE CAST END UPPER
SCREW
(4.8 X 38 SELF TAPPING SCREW)

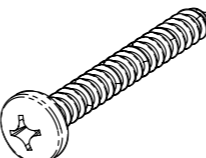

KDS 003 Half Ridge Adaptor Plate Lower Screws

KDS003 HALF RIDGE ADAPTOR PLATE LOWER
SCREWS
(5 X 37 C/SINK WOOD SCREW)

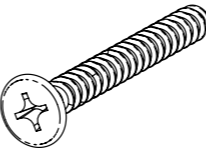

KFD 001 Georgian Cap Finial Disk

KFD001 GEORGIAN CAP FINIAL DISK
(USED WITH KGEA001)



KFKA 001 Internal Radius End Fixing Kit

KFKA001/1 RADIUS END FIXING KIT WHITE

KIT CONTENTS
KBF001 RAD END UNDERCLADDING BRACKET
KLB001 ROSELOCK FIXING BUTTON
SCRA001 ROOFING BOLT AND NUT

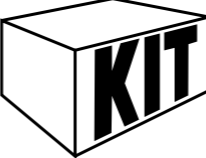

KFT 001 Ridge Flashing Trim

KFT001 RIDGE FLASHING TRIM

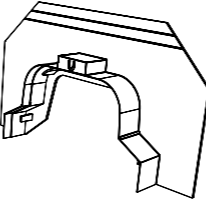

KGEA 001 Gable End Complete

KGEA001 GABLE END CAP COMPLETE
(INCLUDES KFD001 FINIAL DISC)

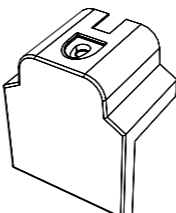

KGR - - - Georgian Internal Separate End Cover

KGR001 GEORGIAN SEP END COVER SMALL
KGR002 GEORGIAN SEP END COVER LARGE

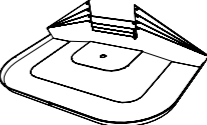

KHB - - - Half Ridge/Lantern Baffle Support Wing

KHB600/35 HALF RIDGE ALUM BAFFLE SUPPORT
WING 6M

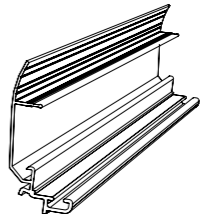

KHC - - - Half Ridge Top Capping

KHC600 HALF RIDGE TOP CAPPING 6M

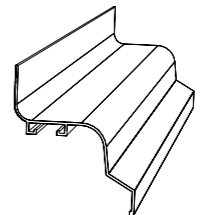

KHF 001 Ridge/Half Ridge Capping Joiner

KHF001 RIDGE/HALF RIDGE CAPPING JOINER
(TOP OF VALLEY)

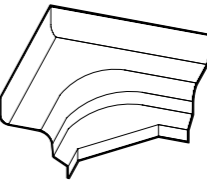

KHG - - - Georgian Half Ridge Radius End Cap

KHG015L-21 15DEG GEORGIAN 21TRIM LEFT
KHG015R-21 15DEG GEORGIAN 21TRIM RHT
KHG025L-21 25DEG GEORGIAN 21TRIM LEFT
KHG025R-21 25DEG GEORGIAN 21TRIM RHT

(ALSO NEED)
VBC044 BRUSH CLIP 440MM
VBLA044/1 RAND END BRUSH 440MM

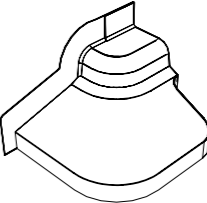

KHI - - - Victorian Half Ridge & Wok Under Capping

KHI001L HR UNDER CAP SM RADIUS LEFT
KHI001R HR UNDER CAP SM RADIUS RIGHT
KHI002L HR UNDER CAP LRG RADIUS LEFT
KHI002R HR UNDER CAP LRG RADIUS RIGHT

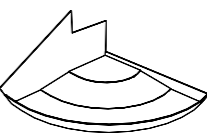

KHI - - - Georgian Half Ridge & Wok Under Capping

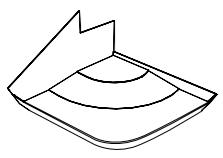

KHI003L	HR UNDER CAP SM RADIUS LEFT
KHI003R	HR UNDER CAP SM RADIUS RIGHT
KHI004L	HR UNDER CAP LRG RADIUS LEFT
KHI004R	HR UNDER CAP LRG RADIUS RIGHT

KHL 001 Half Ridge End Cap (Left)

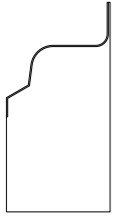

KHL001 HALF RIDGE END CAP (LEFT)
(KHR FOR RIGHT HAND)

KHM - - - Mk5 Half Ridge Main Body

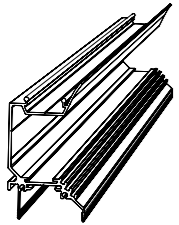

KHM600 HALF RIDGE MAIN BODY 6M

KHR 001 Half Ridge End Cap (Right)

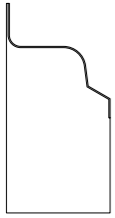

KHR001 HALF RIDGE END CAP (RIGHT)
(KHL FOR LEFT HAND)

KHS 060 Half Ridge Structural Carriage

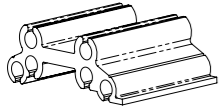

KHS060 HALF RIDGE STRUCTURAL CARRIAGE

KHU - - - Half Ridge/Lantern Under Cladding

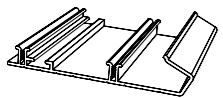

KHU600 UNDERCLADDING 6M WH

KHV - - - Victorian Half Ridge Radius End Cap

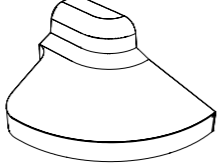

KHV015L-21	15DEG VICTORIAN 21TRIM LFT
KHV015R-21	15DEG VICTORIAN 21TRIM RHT
KHV025L-21	25DEG VICTORIAN 21TRIM LFT
KHV025R-21	25DEG VICTORIAN 21TRIM RHT

(ALSO NEED)
VBC380 BRUSH CLIP 380MM VBLA038/1 RAD END BRUSH 380MM

KLB 001 Rose Locking Fixing Button

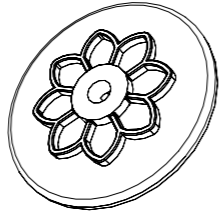

KLB001 ROSE LOCKING FIXING BUTTON
(INC IN KFKA001 KIT)

KMBA - - - Mk5 Full Ridge Main Body (Punched & Meshed)

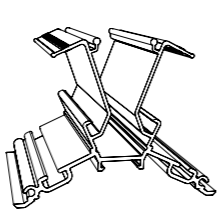

KMBA600/35/15/1	MK5 FULL RIDGE BODY - 15°
KMBA600/35/20/1	MK5 FULL RIDGE BODY - 20°
KMBA600/35/25/1	MK5 FULL RIDGE BODY - 25°
KMBA600/35/30/1	MK5 FULL RIDGE BODY - 30°
KMBA600/35/35/1	MK5 FULL RIDGE BODY - 35°
KMBA600/35/40/1	MK5 FULL RIDGE BODY - 40°

KOB 002 Ventilation Button



KOB002 VENTILATION OPERATION BUTTON
(MAIN RIDGE UNDERCLADDING)

KRB - - - Rain Baffle Back Section

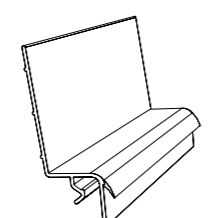

KRB600/35BL RAIN BAFFLE BACK SECTION
35MM BLACK 6M

KRSB - - - Rain Baffle

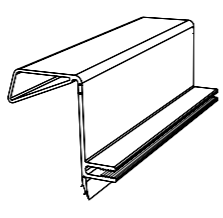

KRSB637/16L	7 SE'S 25MM LOW PITCH 6.3m
KRSB637/16S	7 SE'S 25MM STEEP PITCH 6.3m
KRSB637/32L	7 SE'S 35MM LOW PITCH 6.3m
KRSB637/32S	7 SE'S 35MM STEEP PITCH 6.3m

KTBA 001 Ridge T Bolt and Fixing Wedge

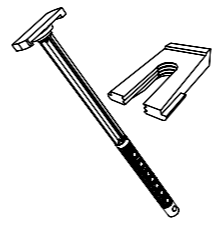

KTBA001/1	RIDGE T BOLT
KTBA001/2	FIXING WEDGE

(IN CONJUNCTION WITH KAC 035)

KVRA - - - Radius End Undercladding

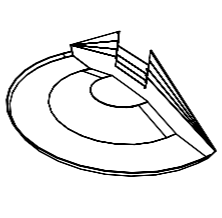

KVRA001	SMALL RADIUS END UNDERCLADDING
KVRA002	LARGE RADIUS END UNDERCLADDING

PSF 004 Pikestaff Finial

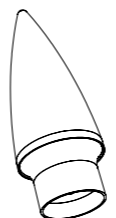

PSF004 PIKESTAFF FINIAL

PWLA - - - Lean-to Wallplate Body



PWLA600/1 LEAN TO WALL PLATE BODY
5-45 DEG WALL PLATE 6M
(NO TOP CAPPING SUPPLIED)

RAP - - - Ridge Adaptor



RAP001	CAST RIDGE ADAPTOR 25-30 DEG
RAP002	CAST RIDGE ADAPTOR 15-20, 35 DEG
RAP003	CAST RIDGE ADAPTOR 40 DEG

RCS - - - Ridge Structural Carriage Screws

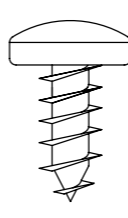

RCS001	RIDGE CARRIAGE SCREWS 4.2 X 13MM
RCS002	HALF RIDGE WING TO MAIN BODY 4.2 X 10MM

RHK 001 Ridge Hanger Kit (TBRK)

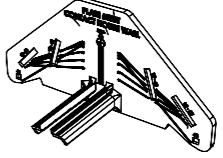

RHK001	RIDGE HANGER KIT
--------	------------------

KIT CONTENTS

SRCP001	COMPRESSION PLATE (1)
SSBR030	STARTER REINFORCEMENT (2)
RHSK001	HANGER SUB KIT
SRE003	TBRK LABEL
CIL178	CONTENTS LIST

SARC - - - Ridge Bolster (TBRK)

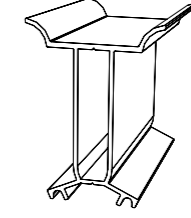

SARC600 RIDGE BOLSTER

SBB 001 Starter Bar Fixing Bracket



SBB001 STARTER BAR FIXING BRACKET

SFNA 004 Coronet Finial

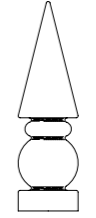

SFNA004 CORONET FINIAL

SFS 001 Speedlok 2 Fixing Screw



SFS001 SPEEDLOK 2 FIXING SCREW

SHI - - - Internal Radius End Covers



- SHI001L Vic Small Int Rad End Cover H/R
- SHI001R Vic Small Int Rad End Cover H/R
- SHI002L Vic Large Int Rad End Cover H/R
- SHI002R Vic Large Int Rad End Cover H/R
- SHI003L Geor Small Int Rad End Cover H/R
- SHI003R Geor Small Int Rad End Cover H/R
- SHI004L Geor Large Int Rad End Cover H/R
- SHI004R Geor Large Int Rad End Cover H/R
- SHI010/1 Rose Fixing Plate Assembly
- SHI010/2 Nylon Washer Nut

SSC 001 Speedlok Housing Spacer



- SSC001 SPEEDLOK HOUSING SPACER

TFR 200 Threaded Fixing Rose



- TFR200 THREADED FIXING ROSE
(INT RAD END TO LOW PRO CREST)
- ALSO USED ON FULL WOK

TWR 001 Wok Threaded Fixing Rose

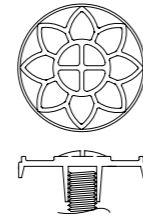

- TWR001 WOK THREADED FIXING ROSE 100MM
- TWR001L WOK THREADED FIXING ROSE 150MM

UOB 001 Opening Button

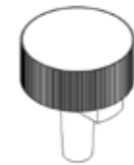

- UOB001 OPENING BUTTON ON
UNDERCLADDING
- (HALF RIDGE OR VENTILATED WALLPLATE)

UWC - - - Half Ridge Flymesh

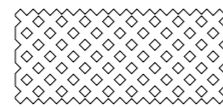

- UWC600/1 FLYMESH STRIP (18MM)
- HALF RIDGE

VSR 001 Plastic Snap Rivet - Ridge Cap

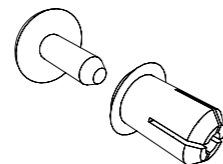

- VSR001 PLASTIC SNAP RIVETS-RIDGE CAP

SLH - - - Die Cast Ridge Weathering Shield

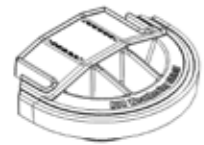

- SLH002 HUB WEATHERING SHIELD
- SLH006 FULL WOK WEATHERING SHIELD
- SLH007 QUARTER WOK WEATHERING SHIELD
- SLH008 3/4 'L' WEATHERING SHIELD
- SLH013 3/4 WOK WEATHERING SHIELD
- SLH014 1/2 WOK WEATHERING SHIELD

SLH - - - Die Cast Ridge End



- SLH004 SPEEDLOK HUB 1/4 ADAPTOR
- SLH005 TIE BAR/ BRACKET FOR INT RAD FIX
- SLH009 FULL WOK DIE CAST END
- SLH010 3/4 WOK DIE CAST END
- SLH011 1/2 WOK DIE CAST END
- SLH012 1/4 WOK DIE CAST END
- SLH015 1/2 RIDGE L SHAPE HUB SUPPORT
BRACKET

SLHA - - - New Die Cast End - Half Ridge



- SLHA001 SPEEDLOK HUB
- SLHA001L SPEEDLOK HALF RIDGE HUB
- SLHA001R SPEEDLOK HALF RIDGE HUB
- SLHA003 SPEEDLOK EXT CORNER DIE CAST

(THE ABOVE USED FOR HALF RIDGES- CUT TO SUIT)

SSA 001 Speedlok 2 Socket Assembly



- SSA001 SPEEDLOCK 2 SOCKET ASSEMBLY

WCP 001 Ventilated Wallplate 5 Degree Packer

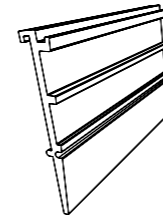

- WCP001/1 WALLPLATE 5° PACKER
- (PITCHES FROM 15 TO 30 DEGS)

WCS - - - Ventilated Wallplate Carriage

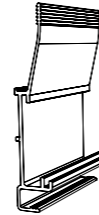

- WCS100/35 WALLPLATE CARRIAGE 100MM

WEC 001 Ventilated Wallplate End Cap

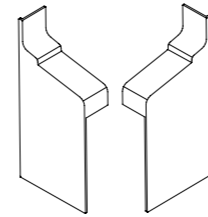

- WEC001/L WALLPLATE END CAP (LEFT)
- WEC001/R WALLPLATE END CAP (RIGHT)

WMB - - - Ventilated Wallplate Main Body

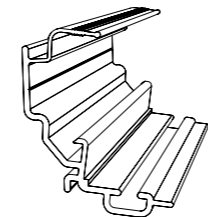

- WMB60035/1 WALLPLATE MAIN BODY (5-10°)
- WMB60035/2 WALLPLATE MAIN BODY (10-15°)

WTC - - - Ventilated Wallplate Top Capping

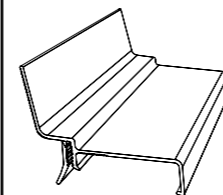

- WTC600/1 WALLPLATE TOP CAPPING

WUC - - - Ventilated Wallplate Undercladding

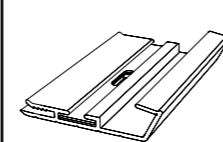

- WUC600 INCLUDING MESH OR BUTTON
- WUC600/1 WALLPLATE UNDERCLADDING
INCLUDING VENT STRIP

SECTION 3 - Glazing bars

Glazing bars are the members that retain the glazing material and take structural loads down to the eaves

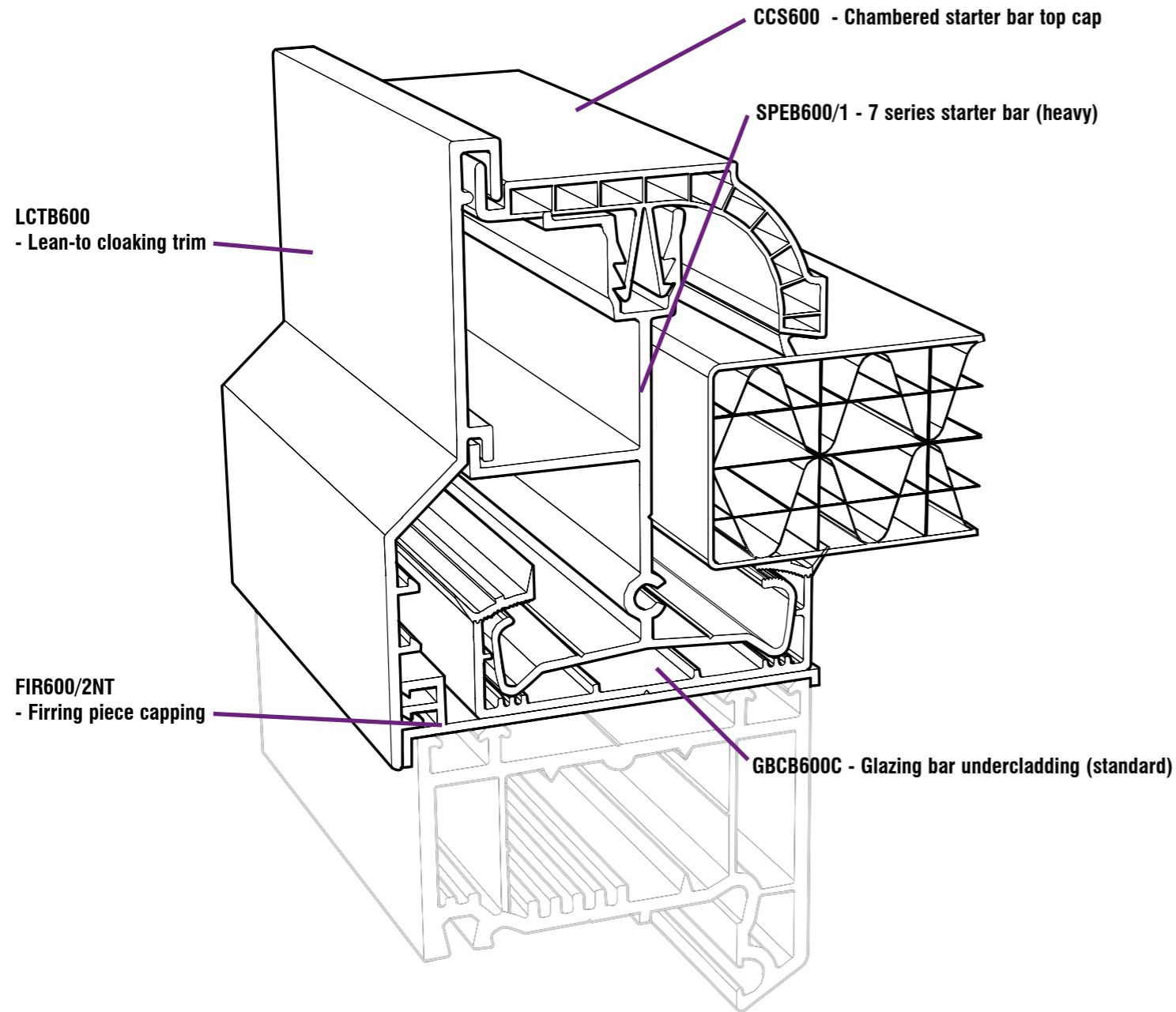

AGC- - - Georgian Top Cap - Aluminium

AGC---/25 GEORGIAN TOP CAP

AGS- - - Qlon Gasket

AGS250 QLON GASKET
AGS350 QLON GASKET

ALC- - - Lean to Cloaking Trim - Aluminium

ALC---/1 LEAN TO CLOAKING TRIM

ASC- - - Starter Bar Top Cap - Aluminium

ASC---/25 STARTER BAR TOP CAP

ATC- - - Transom Top Cap - Aluminium

ATC---/25 TRANSOM TOP BAR

BEC 001 Bolster Bar End Cap

BEC001 BOLSTER BAR END CAP

BFK 020 Bolster Bar Fixing Kit

BFK020 BOLSTER BAR FIXING KIT PACK INCLUDING SELF SEALING WASHER (6.3 X 25) (PACK OF 20)

BFS 001 Bolster Fixing Screw

BFS001 BOLSTER BAR FIXING SCREW

CAPA - - - Glazing Bar Top Cap

CAPA6011 GLAZING BAR TOP CAP STARTER
CAPA604 GLAZING BAR TOP CAP VIC/TRANSOM
CAPA606 GLAZING BAR TOP CAP GEORGIAN
(24/25MM GLAZING ONLY)

REMEDIALS ONLY

CCA - - - Chambered Glazing Bar Top Cap (Dome)

CCA600_/25 TRANSOM CAPPING 25MM
CCA600_/35 TRANSOM CAPPING 35MM

CCE 001 Chambered Starter Bar End Cap

CCE001L_ - CHAMBERED STARTER BAR END CAP (LEFT)
CCE001R_ - CHAMBERED STARTER BAR END CAP (RIGHT)

'Snap out' bar end cap fixing blocks

CCE 002 Chambered End Cap (Gable/Lean-to)

CCE002L_ - CHAMBERED END CAP GABLE/LEANTO (LEFT)
CCE002R_ - CHAMBERED END CAP GABLE/LEANTO (RIGHT)

'Snap out' bar end cap fixing blocks

CCG - - - Chambered Georgian Glazing Bar Top Cap

CCG600_/25 GEORGIAN CAPPING 25MM
CCG600_/35 GEORGIAN CAPPING 35MM

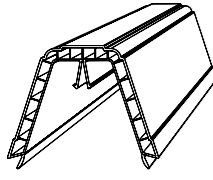

*USE WITH DOME OR BEVEL DESIGN

CCG 001 Chambered Georgian Glazing Bar End Cap

CCG001_ CHAMBERED GEORGIAN END CAP



CCS - - - Chambered Starter Bar Top Cap

CCS600_/25 - CHAMBERED STARTER BAR TOP CAP 25
CCS600_/35 - CHAMBERED STARTER BAR TOP CAP 35

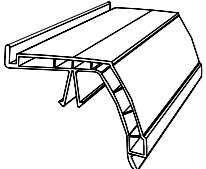

*USE WITH DOME OR BEVEL DESIGN.

CCT - - - Chambered Glazing Bar Top Cap (Bevel)

CCT600_/25 TRANSOM CAPPING 25MM
CCT600_/35 TRANSOM CAPPING 35MM

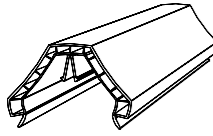

CCTA 001 Chambered Glazing Bar End Cap (Dome)

CCTA001 DOME CHAMBERED TRANSOM END CAP



Snap out' bar end cap fixing blocks

DCM 001 Decorative End Cap Rose Motif

DCM001 DECORATIVE END CAP ROSE MOTIF
(ONE NEEDED WITH EACH END CAP)

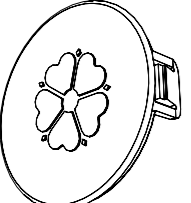

DCM 001/WV Decorative End Cap Circle

DCM001/WV DECORATIVE END CAP CONCENTRIC CIRCLE
(ONE NEEDED WITH EACH END CAP)



DGCE 010 Glass Clip Pack

DGCE010 GLASS CLIP PACK (5 LEFT, 5 RIGHT)



DSBC600C Glazing Bar Cladding

DSBC600C GLAZING BAR CLADDING



EFSA 021 Endcap Fixing Screw

EFSA021 STANDARD (20 PACK)
(4.8 X 25 SELF TAPPING SCREW)

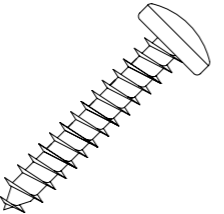

FIR - - - Furring Piece Capping (Use with LTCB---)

FIR600/2NT FIRRING PIECE CAPPING 6M NO TAPE
(SEE ALSO LTCB)

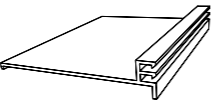

GBCB - - - Glazing Bar Undercladding (Standard)

GBCB600C GLAZING BAR CLADDING 6M WHITE

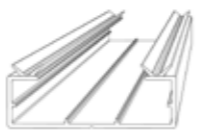

GCRA 002 Glazing Bar Top Cap Removal Tool

GCRA002 GLAZING BAR TOP CAP REMOVAL TOOL

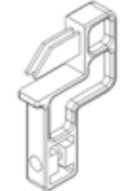

IRK - - - Inter Rafter Kit

IRK001 INTER RAFTER TENNON
IRK002 STRUCTURAL JACK RAFTER BASE KIT
IRK003 INTER RAFTER WEATHERING SHIELD
IRK005 FLASHING TRIM- RUNNER



JRKA - - - Jack Rafter Kit

JRKA001/2 JACK RAFTER CHANNEL INFIL 15MM
JRKA002 JACK RAFTER KIT(7)
JRKA003 JACK RAFTER KIT 7+ REINF BAR
JRKA004/1 M4 X 12 PZ PAN
JRKA004/3 M6 FM B PLAIN WASHER

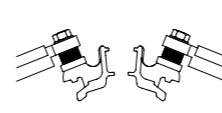

JRT 015 Jack Rafter Tenon

JRT015 JACK RAFTER TENON



JRT 027 Structural Jack Rafter Tenon

JRT027 STRUCTURAL JACK RAFTER TENON

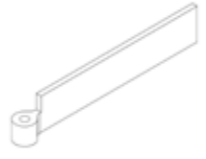

LCTB - - - Lean-to Cloaking Trim

LCTB600 LEAN-TO CLOAK TRIM 6M
(SEE ALSO FIR)

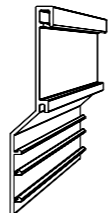

LSL 001 Long Speedlock 2 Assembly

LSL001 LONG SPEEDLOCK 2 ASSEMBLY



LVCC 001 Aluminum Top Capping Fixing Cap

LVCC001 ALUMINIUM TOP CAPPING FIXING CLIP



LWH 001 Long Speedlok 2 Weathering Hood

LWH001 LONG SPEEDLOK 2 WEATHERING HOOD



MBBA - - - Bolster Bar - Aluminium

MBBA550/1 ALUMINIUM BOLSTER BAR

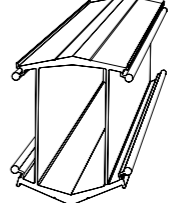

MBB - - - Bolster Bar - PVC Claddings

MBB550/2 BOLSTER PVC CLADDING (FEMALE)
MBB550/3 BOLSTER PVC CLADDING (MALE)

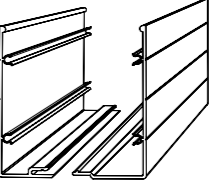

RECA 001 Glazing Bar End Cap - Transom/ Hip

RECA001 GLAZING BAR END CAP (MOTIF)
FIXING PLATE (ALREADY ATTACHED)
Used also on Bevelled PCV Top Cap



REMEDIALS ONLY

RECA - - - Glazing Bar End Cap - Starter

RECA001L STARTER END CAP (MOTIF) LEFT
 RECA001R STARTER END CAP (MOTIF) RIGHT



REMEDIALS ONLY

FIXING PLATE
 (ALREADY ATTACHED)

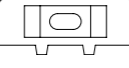

Used also on Bevelled PCV Top Cap

**RECB 002 Glazing Bar End Cap
 (lean-to and gable application)**

RECB002L LEAN-TO & GABLE END CAP (MOTIF) LEFT
 RECB002R LEAN-TO & GABLE END CAP (MOTIF) RIGHT



REMEDIALS ONLY

FIXING PLATE
 (ALREADY ATTACHED)

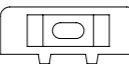

Used also on Bevelled PCV Top Cap

SPE - - - 7 Series Starter Bar (Light)

SPE600L/1 LIGHT STARTER BAR 6M

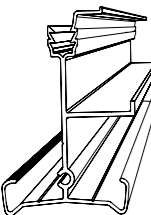

SPE - - - 7 Series Starter Bar (Medium)

SPE600M/1 STARTER GLAZING BAR (78) 6M



SPGA - - - 7 Series Georgian Bar (Light)

SPGA600L/1 LIGHT GEORGIAN HIP BAR 6M

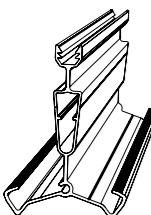

SPGC - - - 7 Series Georgian Bar (Heavy)

SPGC600/1 GEORG HIP GLAZING BAR (78MM) 6M



SPT 600L/1 7 Series Transom/Vic Bar (Light)

SPT600L/1 LIGHT TRANS/VIC GLAZING BAR 6M

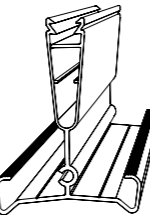

SPT 600M/1 7 Series Transom/Vic Bar (Medium)

SPT600M/1 MEDIUM TRANS/VIC GLAZING BAR 6M



SPTA - - - 7 Series Transom/Vic Bar (Heavy)

SPTA600/1 TRANSOM GLAZING BAR (78MM) 6M

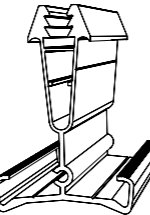

SRGB - - - Georgian Structural Reinforcement

SRGB600 GEORGIAN STRUCTURAL REINFORCEMENT 6M

PLEASE USE TWO PIECES PER BAR
 USE JRKA004/1 (SCREW) TO SECURE

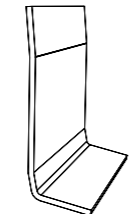

SRTB - - - Transom Structural Reinforcement

SRTB600 TRANSOM STRUCTURAL REINFORCEMENT 6M

PLEASE USE TWO PIECES PER BAR
 USE JRKA004/1 (SCREW) TO SECURE

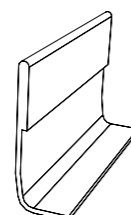

SSL - - - Short Speedlok 2 Assembly

SSL001 SHORT SPEEDLOK 2 ASSEMBLY

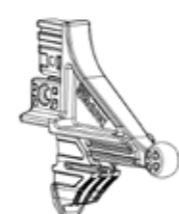

SWH - - - Weathering Hood Short

SWH001 WEATHERING HOOD SHORT



TCAC - - - Anchor Clips

TCAC500 ANCHOR CLIPS (PACK OF 500)



SECTION 4 - Valley

Another structural member that links the ridge to the eaves. It enables more complex roof shapes to be designed

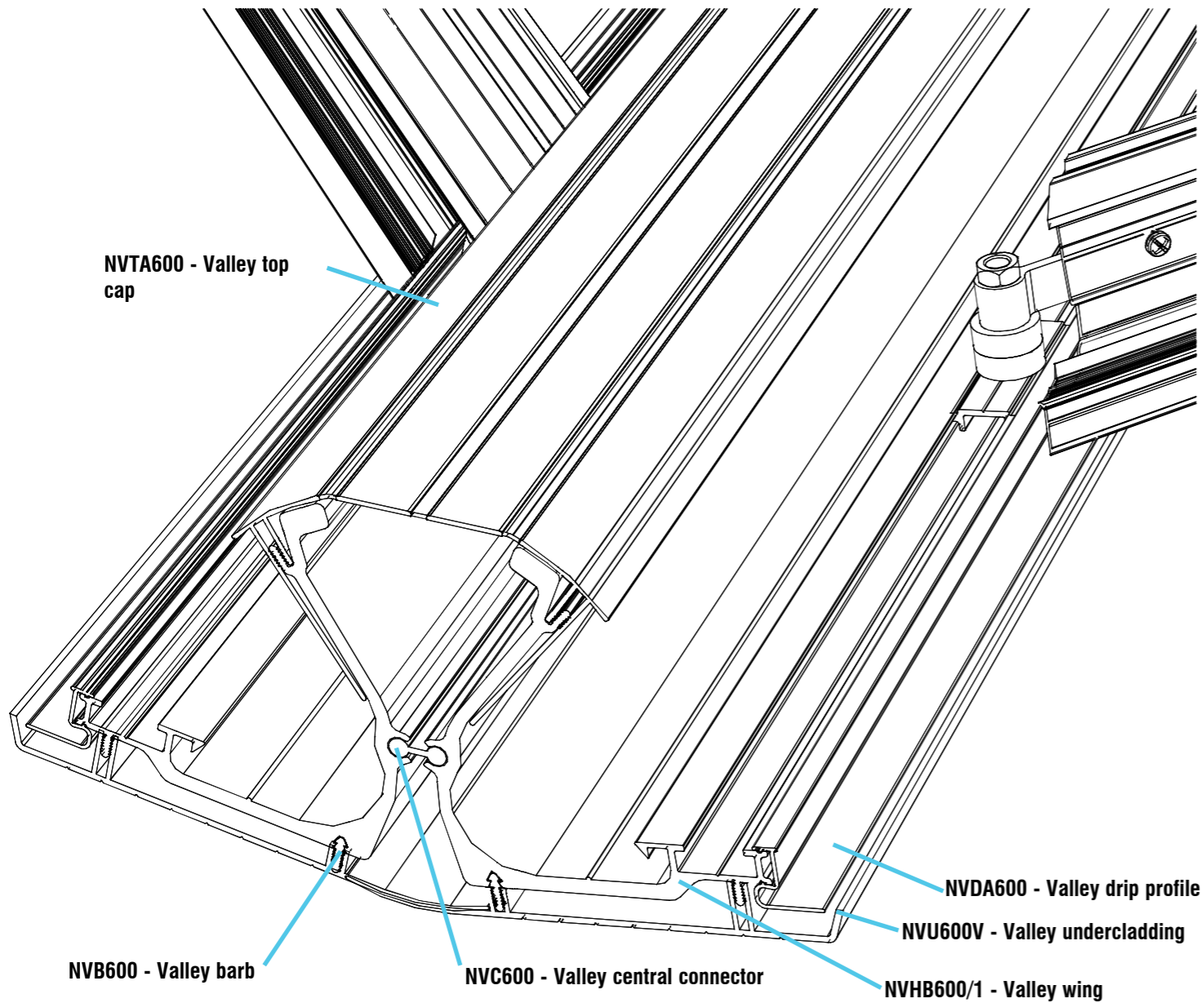

NVB - - - Valley Barb

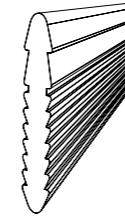

NVB600 VALLEY BARB 6M
(TWO PER VALLEY)

NVC - - - Valley Central Connector

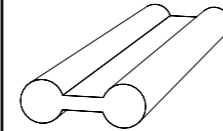

NVC600 VALLEY CENTRAL CONNECTOR 6M

NVDA - - - Valley Drip Profile

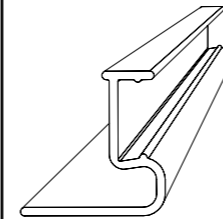

NVDA600 VALLEY DRIP PROFILE 6M

NVE 002 Valley End Cap/ Fixing Kit

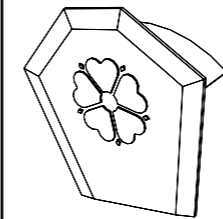

NVE002 VALLEY END CAP/FIXING KIT(4M/6M)
(INCLUDES - VSR001 PLASTIC SNAP RIVETS)

NVHB - - - Valley Wing

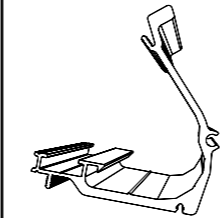

NVHB600/1 VALLEY WING 6M

NVTA - - - Valley Top Cap

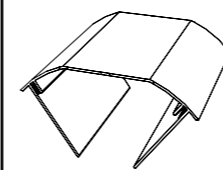

NVTA600 VALLEY TOP CAP 6M

NVU - - - Valley Undercladding V Groove

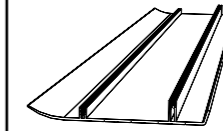

NVU600V VALLEY UNDERCLADDING 6M WHITE
(TWO PER VALLEY)

VPC010 Valley Clip

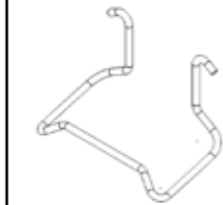

VPC010 VALLEY CLIP

VRK - - - Valley Rafter Kit

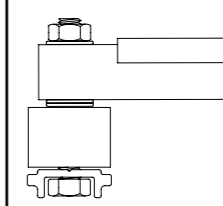

VRK002 VALLEY RAFTER KIT
VRK003 VALLEY RAFTER KIT STRUCTURAL

SECTION 5 - Guttering

Rainwater disposal is essential and in this section are structural box gutters too

For further visual help with box gutter adaptor and rain water pipe outlet identification, please turn to pages 33 & 34

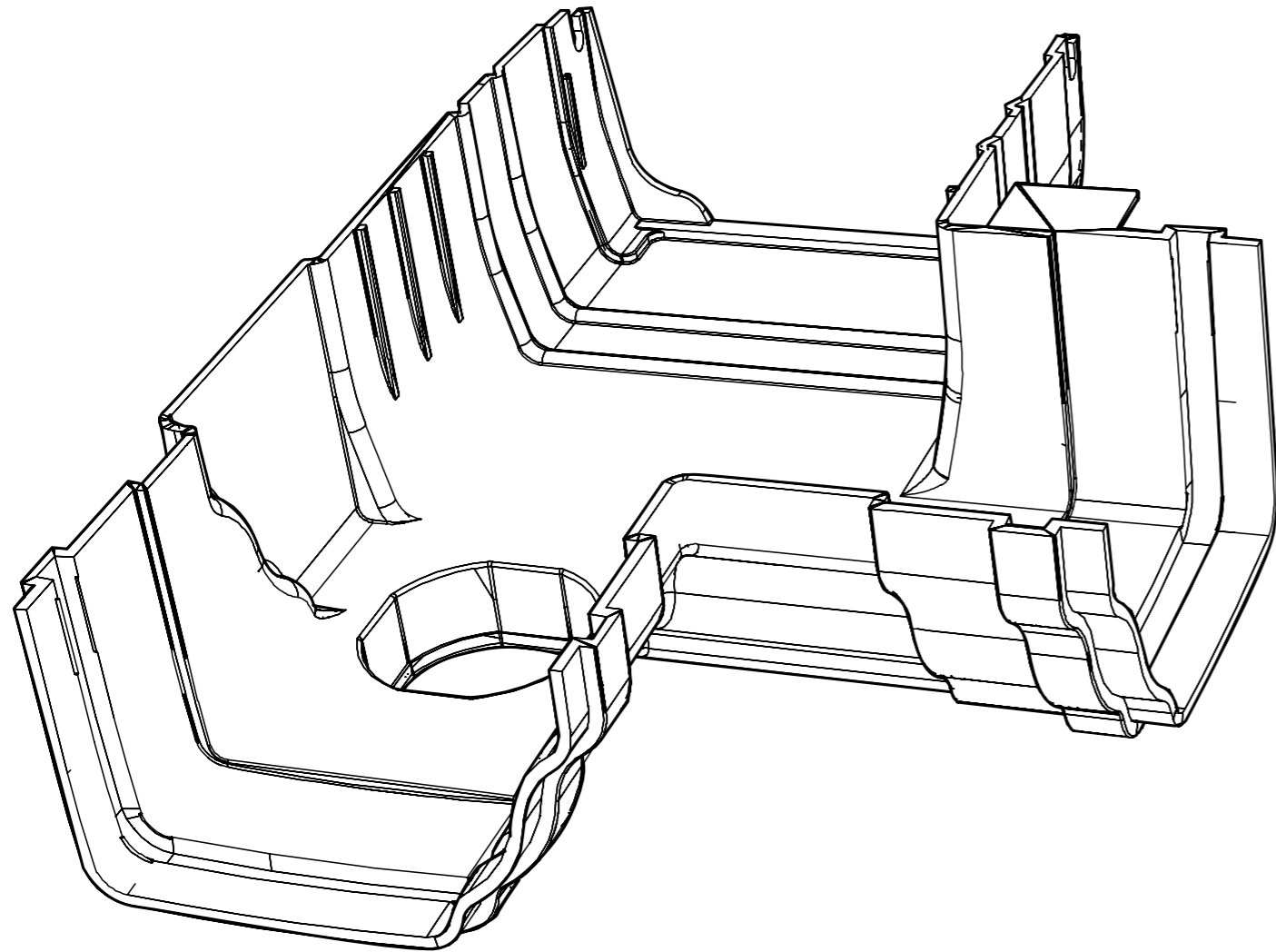

AAHA ---/1 Bolt Slot Attached Raised Back Box Gutter

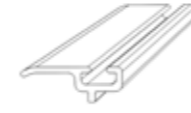

AAHA---/1 BOLT SLOT ATTACHED TO HEAD OF RAISED BACK BOX GUTTER

BAS 075BL Box gutter 75ml Tube of Sealant

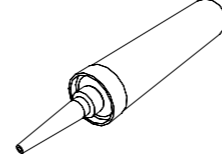

BAS075BL BOXGUTTER 75ML TUBE OF SEALANT (Gutterbond)

BES 001 Bottom Elbow Shoe (RWP)

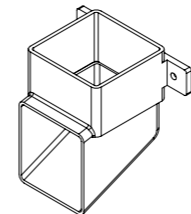

BES001 BOTTOM ELBOW SHOE

BGAA - - - Box Gutter Adaptors (SEE p40)

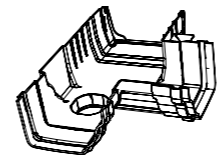

- 165MM ADAPTORS
- BGAA001L/1 STRAIGHT INLINE LEFT
 - BGAA001R/1 STRAIGHT INLINE RIGHT
 - BGAA002L/1 90° LEFT
 - BGAA002R/1 90° RIGHT
 - BGAA003L/1 90° WITH OUTLET LEFT
 - BGAA003R/1 90° WITH OUTLET RIGHT
 - BGAA004L/1 135° WITH OUTLET LEFT
 - BGAA004R/1 135° WITH OUTLET RIGHT
 - BGAA005L/1 INLINE OFFSET LEFT
 - BGAA005R/1 INLINE OFFSET RIGHT
 - BGAA007L/1 90° OFFSET LEFT
 - BGAA007R/1 90° OFFSET RIGHT
 - BGAE001L 90° WITH TRUNK OUTLET LEFT
 - BGAE001R 90° WITH TRUNK OUTLET RIGHT
 - BGSE001L STOP END WITH OUTLET LEFT
 - BGSE001R STOP END WITH OUTLET RIGHT

- 265MM ADAPTORS
- BGAA261L/1 ASSY C/W OUTLET
 - BGAA261R/1 ASSY C/W OUTLET
 - BGAA262L/1 ASSY C/W RETURN
 - BGAA262R/1 ASSY C/W RETURN
 - BGAA263L/1 ASSY + STOP END
 - BGAA263R/1 ASSY + STOP END
 - BGAE263L 90° OFFSET WITH TRUNK OUTLET LEFT
 - BGAE263R 90° OFFSET WITH TRUNK OUTLET RIGHT
 - BGAW001L 90° LEFT
 - BGAW001R 90° RIGHT
 - BGAW002L 90° WITH TRUNK OUTLET LEFT
 - BGAW002R 90° WITH TRUNK OUTLET RIGHT
 - BGAW003L 90° LEFT WITH OUTLET
 - BGAW003R 90° RIGHT WITH OUTLET

BGIA - - - Box Gutter Insulation

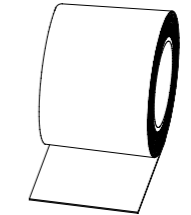

- BGIA422 INSULATION 4M ROLL - 165 b.g
- BGIA622 INSULATION 6M ROLL - 165 b.g
- BGIA432 INSULATION 4M ROLL - 265 b.g
- BGIA632 INSULATION 6M ROLL - 265 b.g

BGRA 005 165mm Box Gutter Reinforcement (strap)

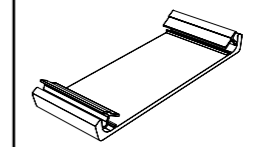

BGRA005/S 165MM REINFORCEMENT 50MM X 5

BST - - - Box Gutter Sealing Tape

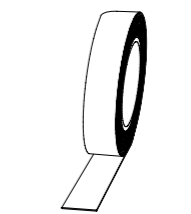

- BST001A BOX GUTTER SEALING TAPE 20M
- BST500A BOX GUTTER SEALING TAPE 500MM

DBU - - - Decorative Box Gutter Cladding

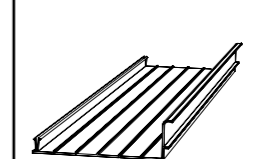

- DBU600S 165MM CLADDING 6M
- DBUA600L 265MM CLADDING 6M

EETA001 Trunk Outlet (Cornice)

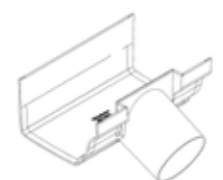

EETA001 TRUNK OUTLET (CORNICIE)

ESA - - - Marley Classic Gutter



- ESA001L MARLEY CLASSIC GUTTER LEFT
 - ESA001R MARLEY CLASSIC GUTTER RIGHT
- (STD 80MM OFFSET TO STEP ROUND STD BRICK)

FBM 600



FBM600 NEW PARABOLIC HEAD USED ON ALL IN HOUSE RAISED BACK BOX GUTTER

FGB 001 Flowline Gutter Bracket Screw Fix



FGB001 SCREW FIX FLOWLINE GUTTER BRACKET

FIA 001 90 Deg Flowline Gutter Angle

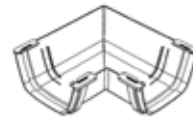

FIA001 90 DEG FLOWLINE GUTTER ANGLE

FJB 001 Gutter Jointer Flowline



FJB001 GUTTER JOINTER FLOWLINE

FRO 001 Running Outlet Flowline



FRO001 RUNNING OUTLET FLOWLINE

FSE - - - Stop End Outlet Flowline



FSE001 STOP END OUTLET FLOWLINE
FSE002 STOP END (NOT HANDED)

GAD - - - Gutter to RWP Adaptor

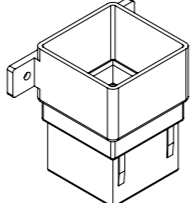

GAD001 GUTTER TO SQUARE RWP ADAPTOR
GAD002 GUTTER TO ROUND RWP ADAPTOR
(GUTTER OUTLET TO RWP AND RWP TO RWP JOINTER)

GBLA 001 Gallows Bracket (265mm Box Gutter)

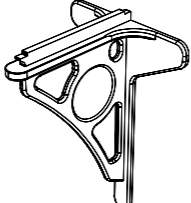

GBLA001 GALLOWS BRACKET 265 MM

GBSA 001 Gallows Bracket (165mm Box Gutter)

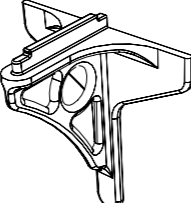

GBSA001 GALLOWS BRACKET 165MM

HOP 001 Hopper Head



HOP001 HOPPER HEAD

MEA 001 Classic Gutter External 90 Degrees

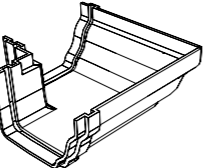

MEA001 GUTTER 4LT EXTERNAL 90 DEG

MGB 002 Classic Gutter Screw on Bracket

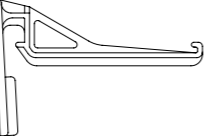

MGB002 4LT SCREW ON GUTTER BRACKET

MGBC 001 Classic Gutter Eaves Beam Bracket

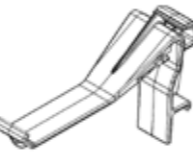

MGBC001 EAVES BEAM GUTTER BRACKET

MGO 001 Special Gutter Outlet/Tank Fitting

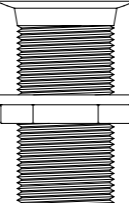

MGO001 SPECIAL GUTTER OUTLET/TANK FITTING (DRILL & FIT)

MGU - - - Classic Gutter

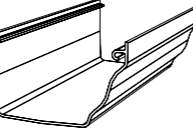

MGU400 GUTTER 4LT 4M

MGU - - - Classic Gutter Angle

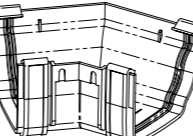

MGU120 GUTTER 4LT 120° ANGLE
MGU125 GUTTER 4LT 125° ANGLE
MGU130 GUTTER 4LT 130° ANGLE
MGU135 GUTTER 4LT 135° ANGLE
MGU135I GUTTER 4LT 135° INTERNAL ANGLE
MGU140 GUTTER 4LT 140° ANGLE
MGU145 GUTTER 4LT 145° ANGLE
MGU150 GUTTER 4LT 150° ANGLE
MGU155 GUTTER 4LT 155° ANGLE
MGU160 GUTTER 4LT 160° ANGLE
MGU165 GUTTER 4LT 165° ANGLE
MGU170 GUTTER 4LT 170° ANGLE

(FABRICATED VARIABLE ANGLES ARE AVAILABLE)

MIA 001 Classic Gutter Internal 90 Degrees

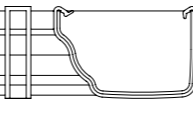

MIA001 GUTTER 4LT INT 90 DEG ANGLE

MJB 001 Classic Gutter Joint Bracket

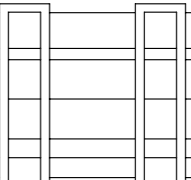

MJB001 GUTTER 4LT JOINT BRACKET

MRIA 001 Inline Running Outlet - On Eaves Beam

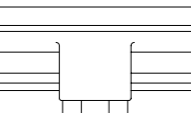

MRIA001 INLINE RUNNING OUTLET (2 X MJB001 REQUIRED)

MRO 001 Running Outlet (Wall Mounted)

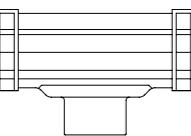

MRO001 RUNNING OUTLET (WALL MOUNTED)

MRSA- - - Stopend Outlet - On Eaves Beam

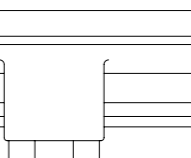

MRSA001 STOPEND OUTLET LEFT
MRSA002 STOPEND OUTLET RIGHT

MSE - - - Classic Gutter Stop Ends

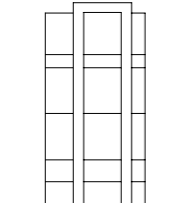

MSE001 GUTTER STOP END LEFT
MSE002 GUTTER STOP END RIGHT

MSO - - - Classic Gutter Stop End Outlet (Wall Mounted)

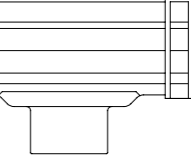

MSO001 GUTTER STOP END OUTLET LEFT
MSO002 GUTTER STOP END OUTLET RIGHT

OET 090 Trunk Outlet 90°

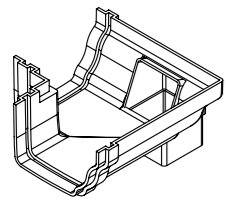

OET090L/R 90° GUTTER TRUNK OUTLET
LEFT (DOWN FRONT LEFT CORNER POST)
MAY ALSO BE USED DOWN SIDE OF FRONT RIGHT CORNER POST (SHOWN). See page 43 for identification of exact needs.

RDP 068 Rainwater Pipe 67° Obtuse Round

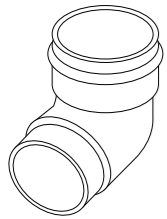

RDP068 PIPE 67° OBTUSE BEND ROUND

RWB 001 Offset Bend Kit

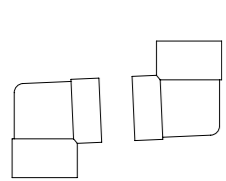

RWB001 OFFSET BEND KIT (SQUARE)

RWC 001 Downpipe Bracket (RWP)



RWC001 SQUARE DOWNPIPE BRACKET(2)

RWO - - - Rainwater Pipe 67° Obtuse Square

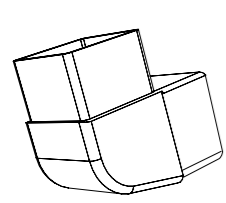

RWO001 PIPE 67 DEG OBTUSE BEND SQUARE
RWO087 PIPE 87 DEG OBTUSE BEND SQUARE

RWP 001 Square Rainwater Pipe Branch

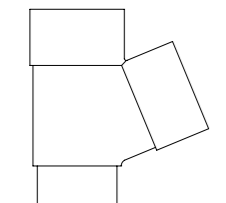

RWP001 RAINWATER PIPE BRANCH

RWP 250 Square Rainwater Pipe



RWP250 RAINWATER PIPE 2.5M

SSGO - - - Trunk Outlet

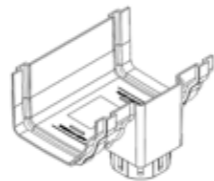

SSGO001 INLINE TRUNK OUTLET
SSGO002 STOP END TRUNK OUTLET L&R
See page 45 for identification of exact needs.

UZBGSB 001 Box Gutter Hanging Bbracket

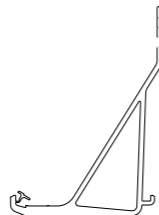

UZBGSB001 BOX GUTTER HANGING BRACKET
(165MM BOXGUTTER ONLY)

UZGU - - - Low Pitch Flowline Gutter



UZGU--- LOW PITCH FLOWLINE GUTTER

UZGU001 Low Pitch Flowline Clip on Gutter Bracket

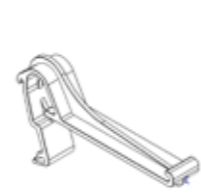

UZGU001 LOW PITCH FLOWLINE CLIP ON GUTTER BRACKET

UZRW 001/1 Round Downpipe Bracket Clip



UZRW001/1 DOWNPIPE BRACKET PIPE CLIP
(CONNECT D.P SHOW TO RWP)

UZRW 001/2 Round Downpipe Socket Clip

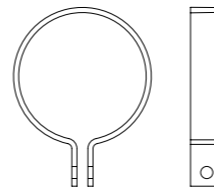

UZRW001/2 DOWNPIPE BRACKET SOCKET CLIP
(CONNECT RWP TO HOST WALL)

UZRW 001/3 Round Downpipe Bracket Backplate

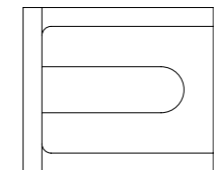

UZRW001/3 DOWNPIPE BRACKET BACKPLATE
(TO CONNECT SOCKET CLIP TO HOST WALL)

UZRW 002 Round Downpipe Shoe

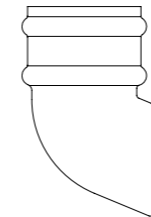

UZRW002 ROUND DOWNPIPE SHOE

UZRW 250 Round Downpipe

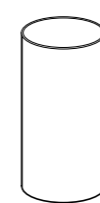

UZRW250 RAINWATER DOWNPIPE

VBGB - - - 165mm Box Gutter

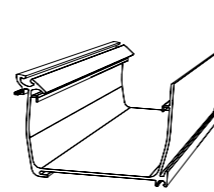

VBGB600PA VICTORIAN 165MM BOXGUTTER ALUMINIUM 6M

VWBA - - - 265mm Box Gutter

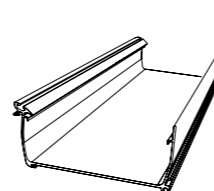

VWBA600/1 265MM BOX GUTTER ALUMINIUM 6M

VWSA - - - 265mm Box Gutter Reinforcement Strap



VWSA001 265 BOX GUTTER REINFORCEMENT STRAP

SECTION 6 - Ancillaries

Included here are specific roof ancillaries such as the TBRK (Tie Bar Replacement Kit) which make the Classic system the clear winner - tried, tested, trusted.

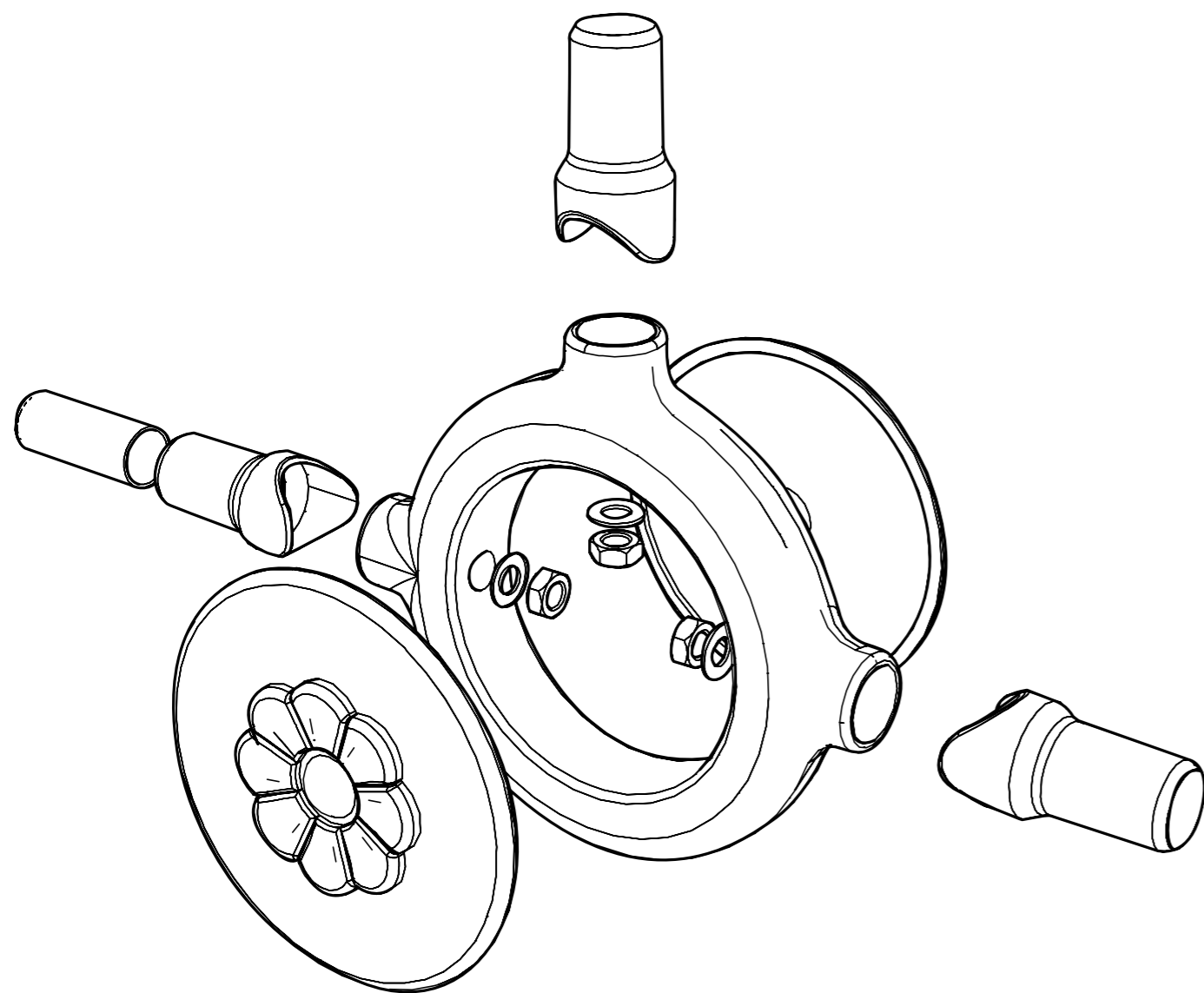

AMB - - - Aluminium Muntin

AMB--/25	ALUMINIUM MUNTIN
AMB--/32	ALUMINIUM MUNTIN

AVS 001 Roof Vent Motor (Switch)

AVS001	ROOF VENT MOTOR SWITCH
--------	------------------------

AVTD 002 Roof Vent Pack (Automatic)

AVTD002	ROOF VENT AUTO PACK INCLUDING THERMOSTAT & RAIN SENSOR
---------	--

BRP - - - Opening Pole (Roof Vent)

BRP001T	BRASS POLE TELESCOPIC 2.5M
BRPA001	BRASS POLE (STD)
BRPA001C	CHROME POLE (STD)

LFF 001 Conservaflash - Saddle Flashing

LFF001	SADDLE FLASHING
--------	-----------------

LFF 001/ Conservaflash - Stepped Units

LFF001/15L/R	L/R STEPPED UNITS 10-15.9°
LFF001/20L/R	L/R STEPPED UNITS 16-20.9°
LFF001/25L/R	L/R STEPPED UNITS 21-25.9°
LFF001/30L/R	L/R STEPPED UNITS 26-30.9°
LFF001/35L/R	L/R STEPPED UNITS 31-35°

LFF - - - Conservaflash Horizontal Flashing 570mm

LFF057	HORIZONTAL FLASHING 570MM
LFF090I	INTERNAL 90° CORNER FLASHING

LFS600 Conservaflash Soaker

LFS600	CONSERVAFLASH SOAKER 6M
--------	-------------------------

LPLL - - - Lightboard

LPLL240 FKIT	2.4M LIGHTBOARD
LPLL120 FKIT	1.2M LIGHTBOARD
LPLL240 HKIT	2.4M LIGHTBOARD
LPLL120 HKIT	1.2M LIGHTBOARD

LVLA 001 Downlights

LVLA001	EYEBALL SPOTLIGHT (BRASS) WITH TRANSFORMER AND WHITE MOUNTING COLLAR
LVLA001B	EYEBALL SPOTLIGHT (BRASS) WITH TRANSFORMER AND BROWN MOUNTING COLLAR
LVLA001CB	EYEBALL SPOTLIGHT (CHROME) WITH TRANSFORMER AND BROWN MOUNTING COLLAR
LVLA001CW	EYEBALL SPOTLIGHT (CHROME) WITH TRANSFORMER AND WHITE MOUNTING COLLAR

NCGS - - - Sealant

NCGS001B	MS POLYMER SEALANT
----------	--------------------

(MUST BE USED ON SELF CLEAN GLASS)

PMB 001 Muntin Bar

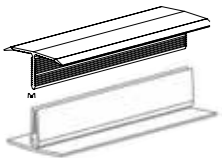

PMB300/1	MUNTIN BAR (ADJOINING SEALED UNITS ONLY) TOP SECTION
PMB300/2	BOTTOM SECTION

Q8750 Roof Vent Motor (Actuator)



Q8750	ROOF VENT MOTOR (ACTUATOR) WHITE
QBL8750	ROOF VENT MOTOR (ACTUATOR) BLACK

RVSA - - -

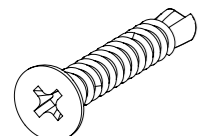

RVSA002	BOLSTER SCREW 4.8 X 32
RVSA013	RE-INFORCING SCREW M4 X 13

RRC 004 M10 Full Nut



RRC004	M10 FULL NUT
--------	--------------

SHBC 001 Square Head Bolt



SHBC001	SQUARE HEAD BOLT
---------	------------------

SLCCU002 Thermostat & Rain Sensor



SLCCU002	ELECTRIC THERMOSTAT & RAIN SENSOR
----------	-----------------------------------

SLCCU003 Radio Control Unit



SLCCU003	RADIO CONTROL UNIT
----------	--------------------

SLRCU003RC Remote Wireless Transmitter



SLRCU003RC	REMOTE WIRELESS TRANSMITTER (FOR SLCCU003)
------------	--

SLVSP- - - Slimline Vent Spindle Kit

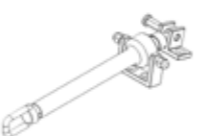

SLVSP001CH	SLIMLINE VENT SPINDLE KIT (CHROME)
SLVSP001BR	SLIMLINE VENT SPINDLE KIT (BRASS)
SLVSP001CH	FIXINGS KIT (CHROME)
SLVSP001BR	FIXINGS KIT (BRASS)

TBBC001/1 Tie Bar Bracket



TBBC001/1	TIE BAR BRACKET
-----------	-----------------

TBBC001/2 Tie Bar Bracket Cover



TBBC001/1	TIE BAR BRACKET COVERS
-----------	------------------------

TBC - - - Tie Bar Conduit

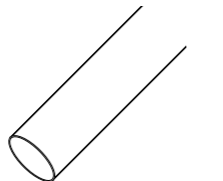

TBC200	TIE BAR CONDUIT 2M
TBC300	TIE BAR CONDUIT 3M

TBPB001 Pivot Bush



TBPB001	PIVOT BUSH
---------	------------

TFKD - - - Tie Bar Fixing Kit



TFKD003	3 WAY TIE BAR FIXING KIT
---------	--------------------------

TFSA 001 Tie Bar Bracket Bolt

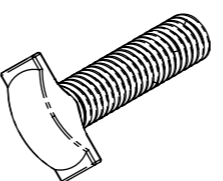

TFSA001	TIE BAR BRACKET BOLT 24MM AND NUT
(USED ONLY WHEN 7 SERIES BAR IS REINFORCED)	

THD 001 T Bar Spanner



THD001	10MM T BAR SPANNER
THD002	13MM T BAR SPANNER

TTB - - - Tie Bar Threaded Bar

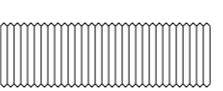

TTB200	TIE BAR THREADED BAR 2M
TTB300	TIE BAR THREADED BAR 3M

165mm

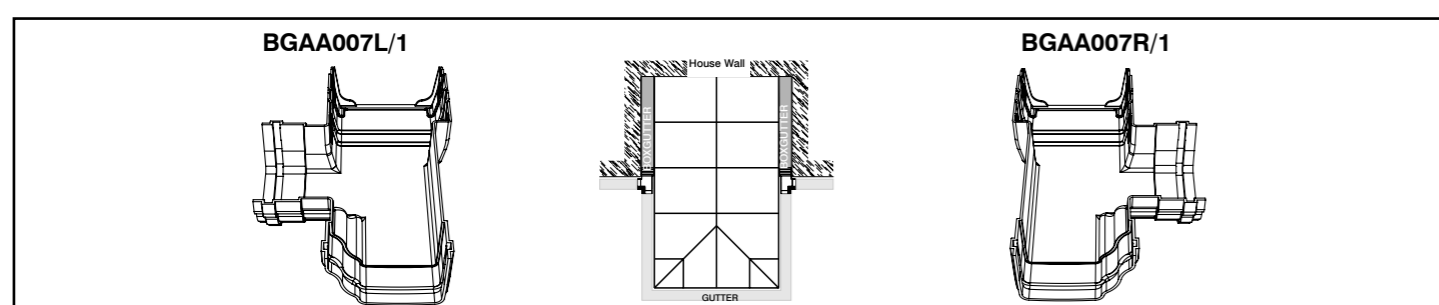
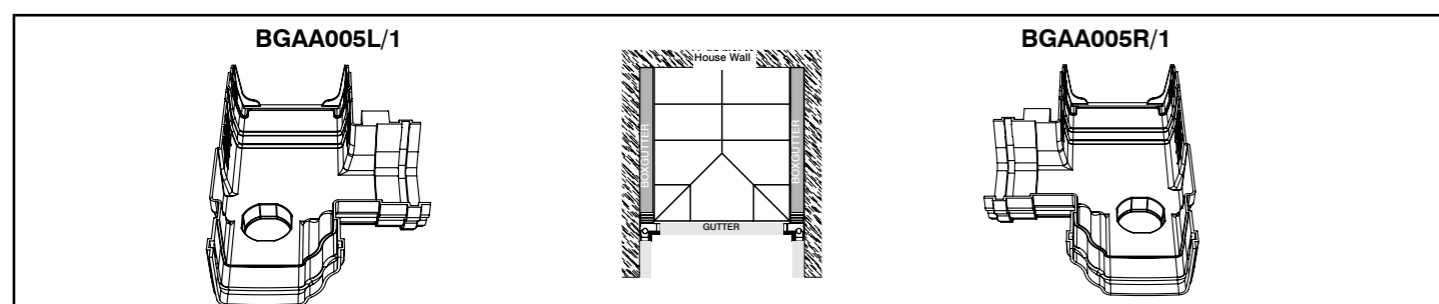
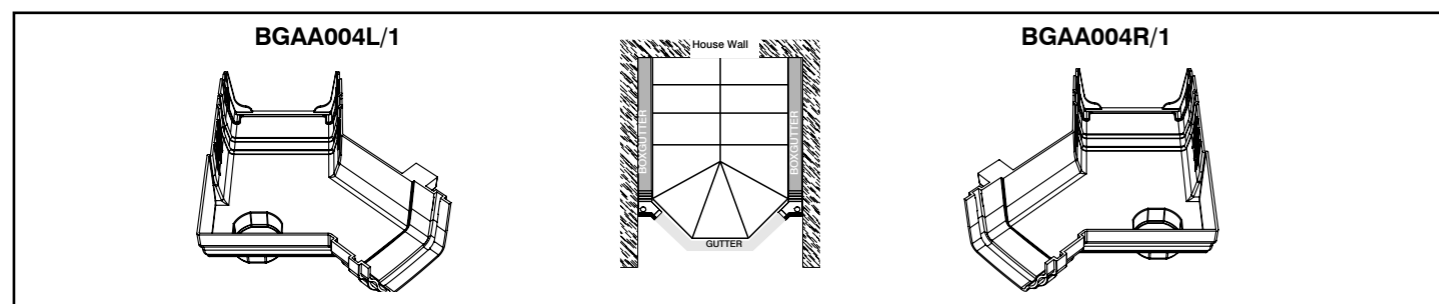
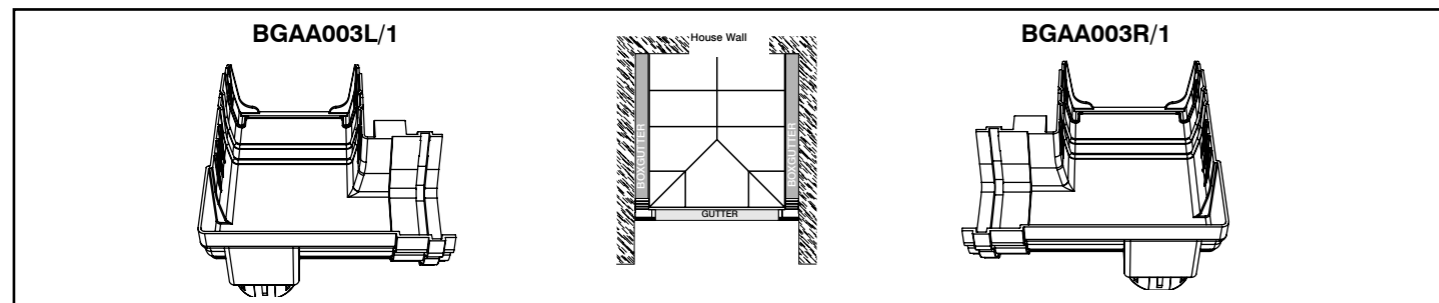
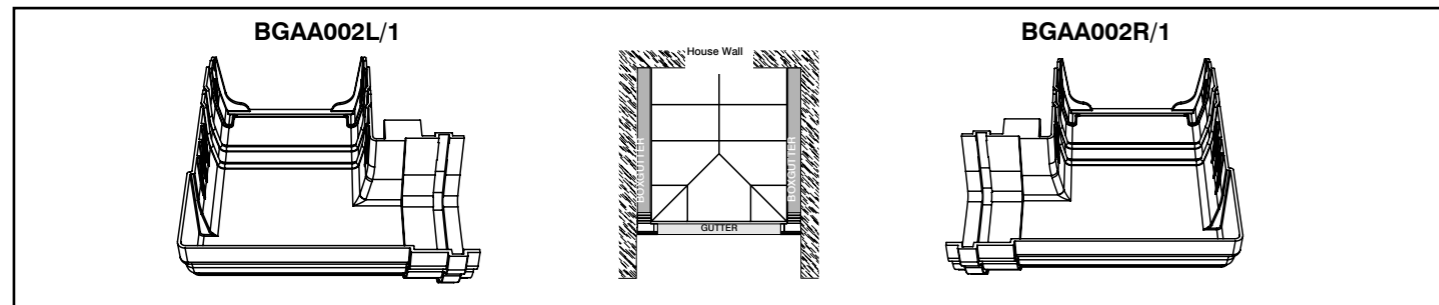
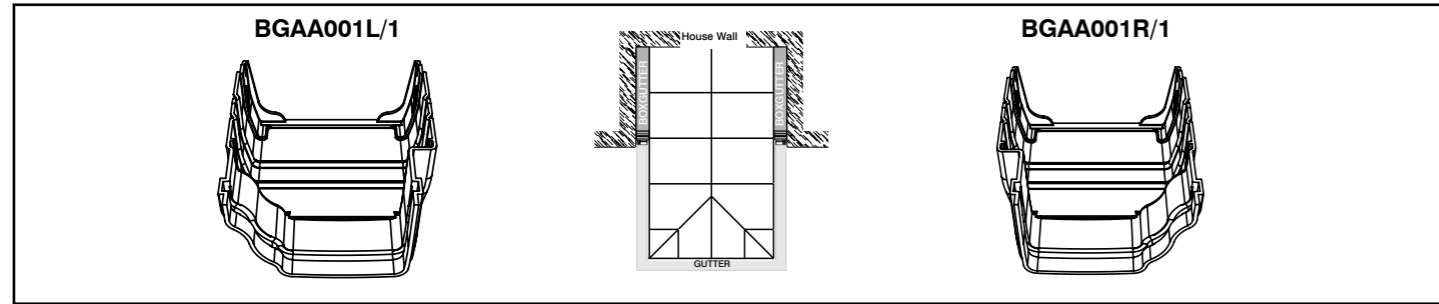

265mm

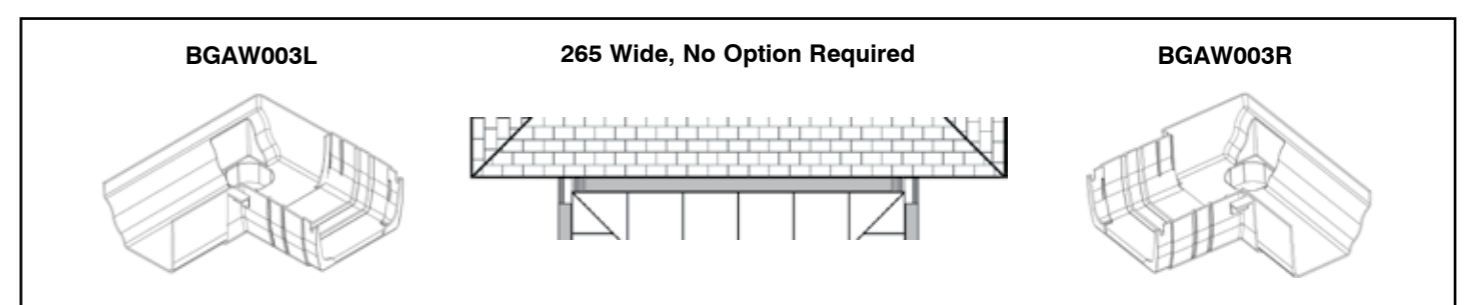
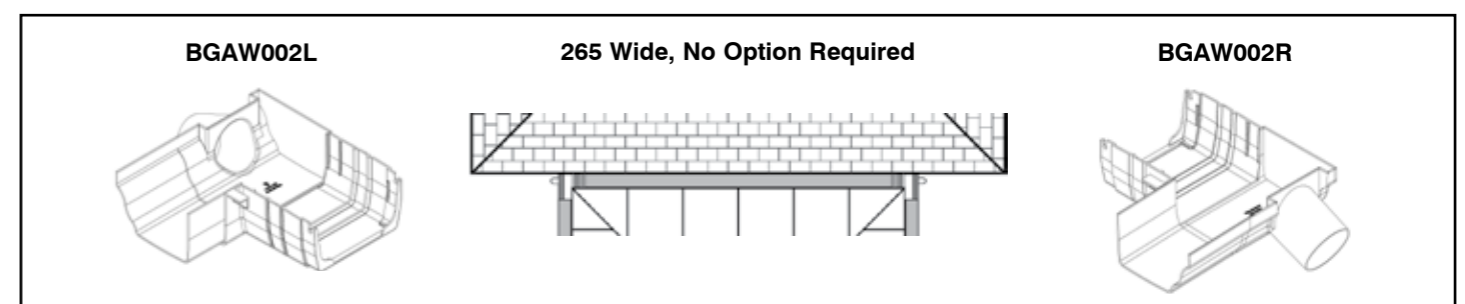
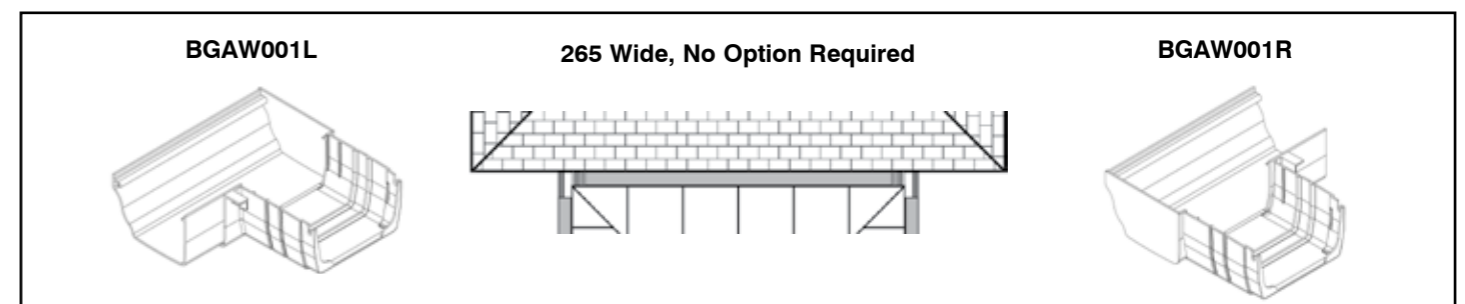
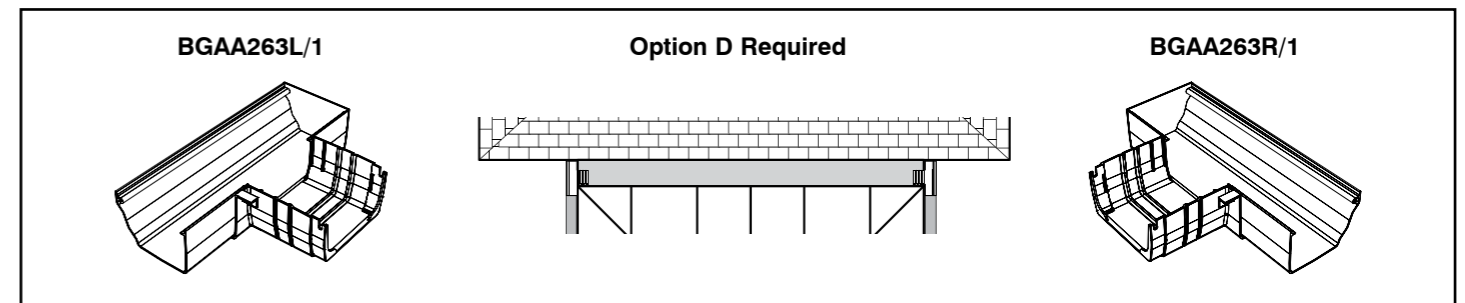
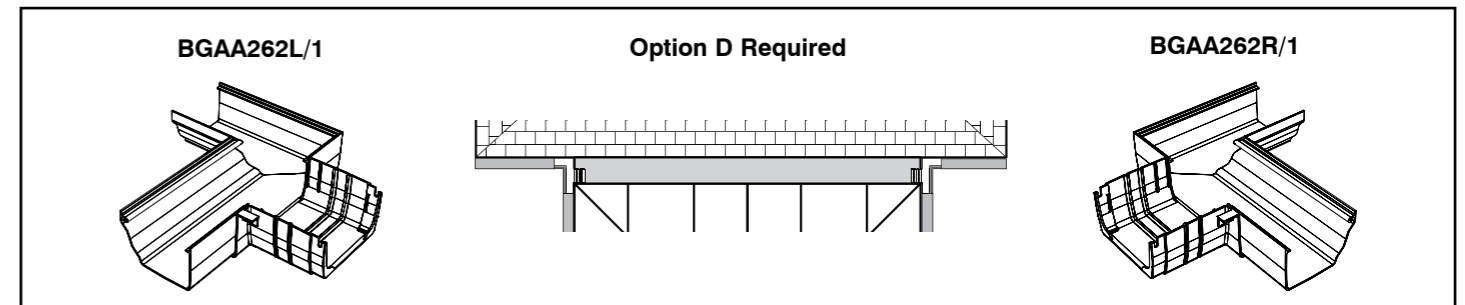
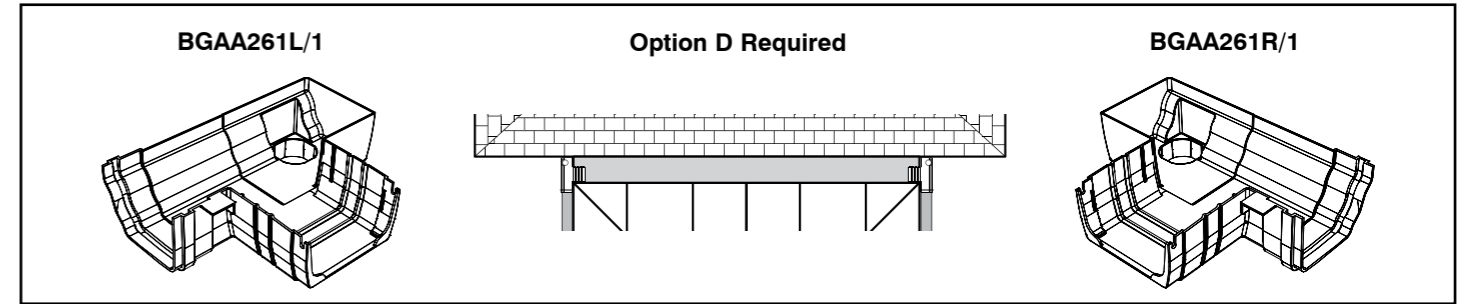

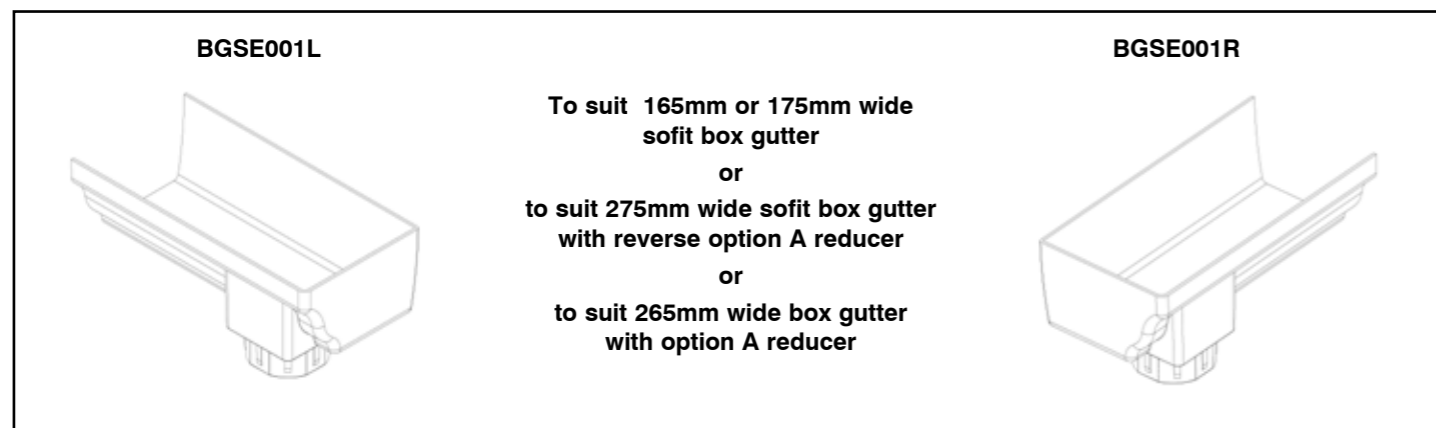
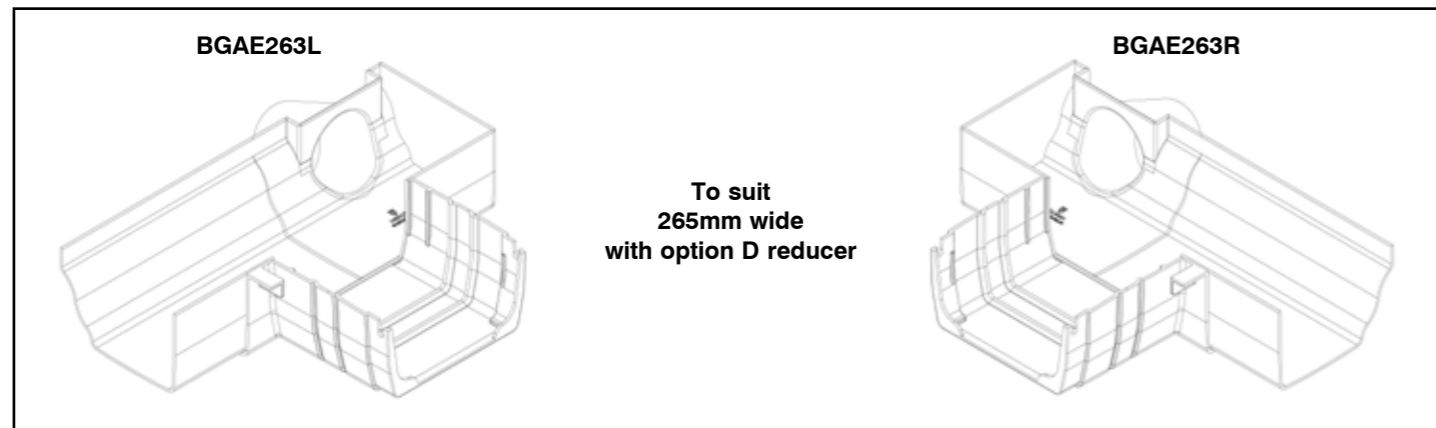
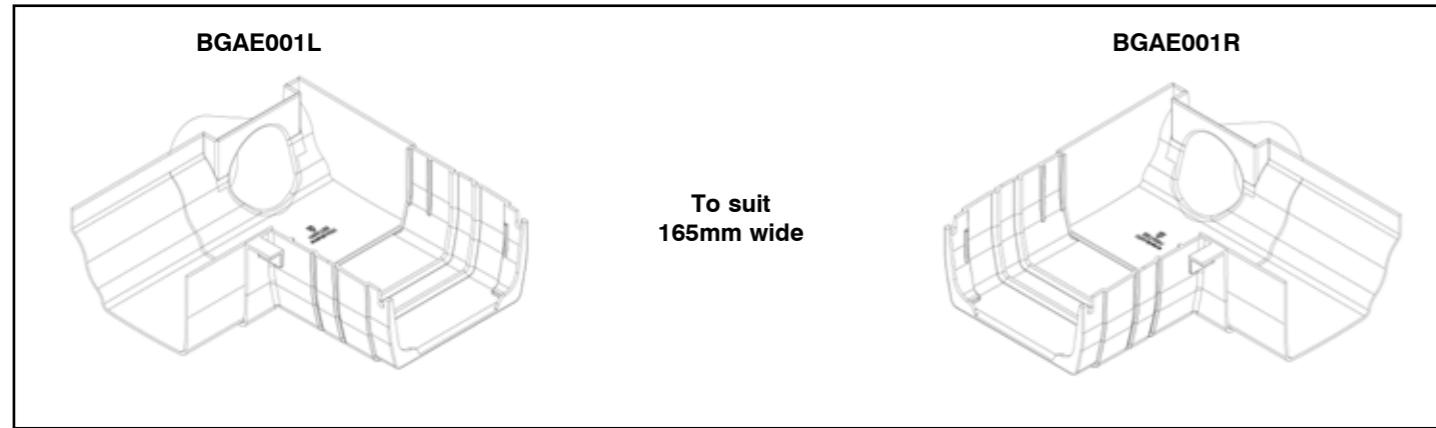

LEFT HAND

RIGHT HAND

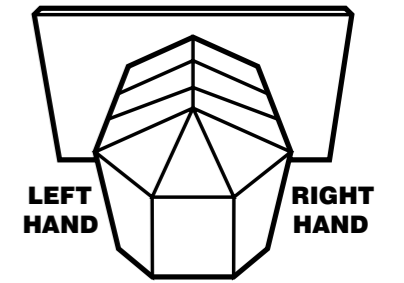
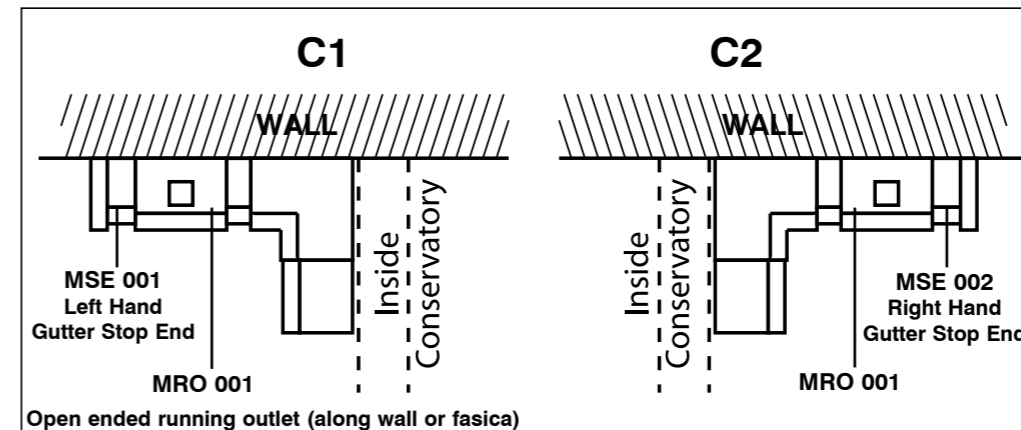
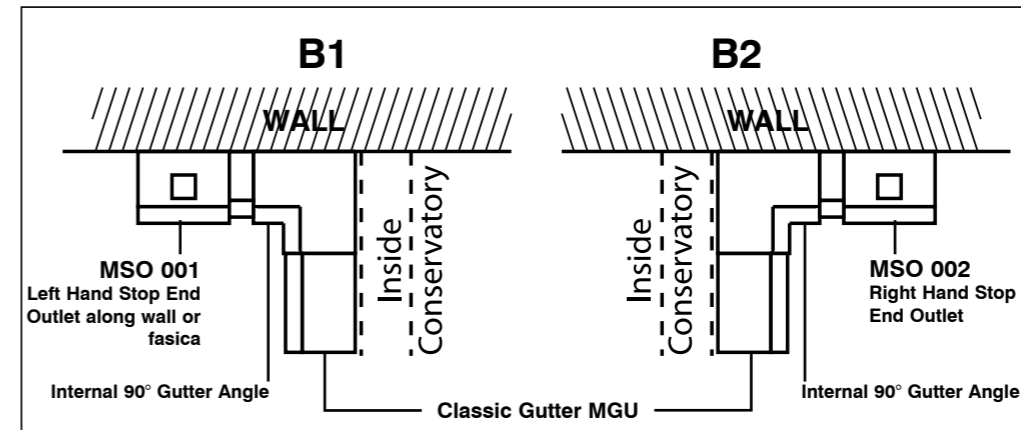
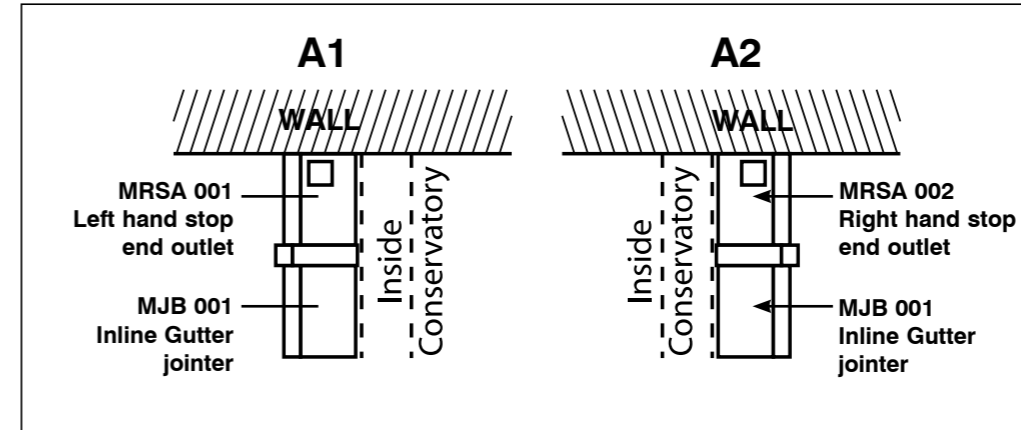

REMEMBER- MARLEY CLASSIC GUTTER IS 'HANDED'

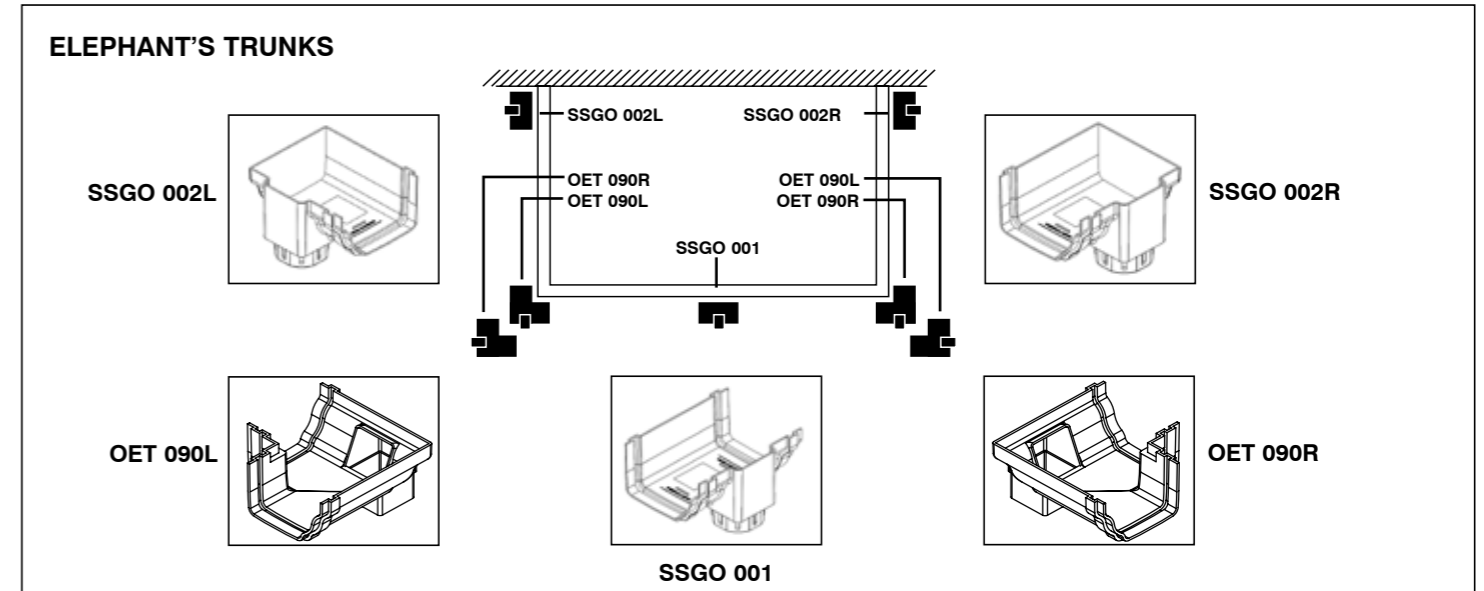
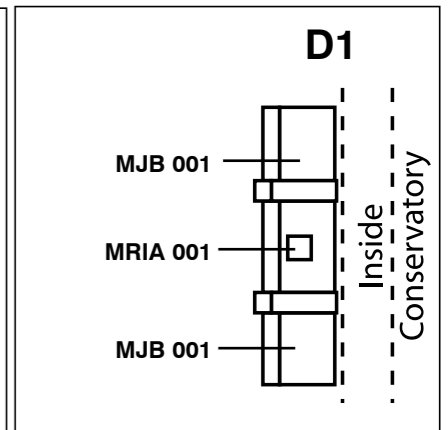

www.ultraframetrade.co.uk



Ultraframe[®]
Transforming light and space

Job No.: 2697 01/20 V7

It is Ultraframe's policy to continually seek to improve its products, processes and services, and we reserve the right to change specifications without prior notice. Ultraframe is a trading name of Ultraframe (UK) Limited.