

# Ultrarroof Thermal Improvements

Additional Parts Supplied. \*Gable situations

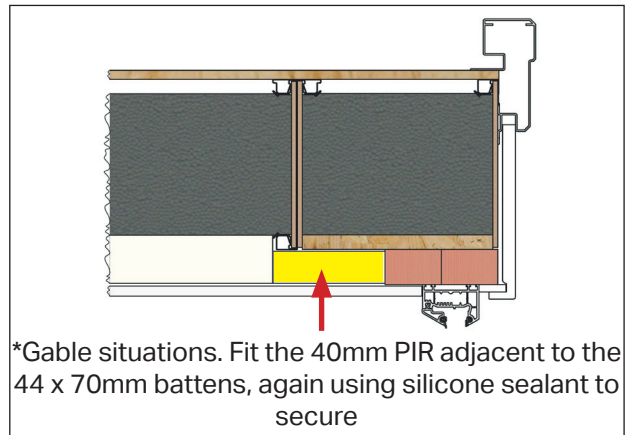
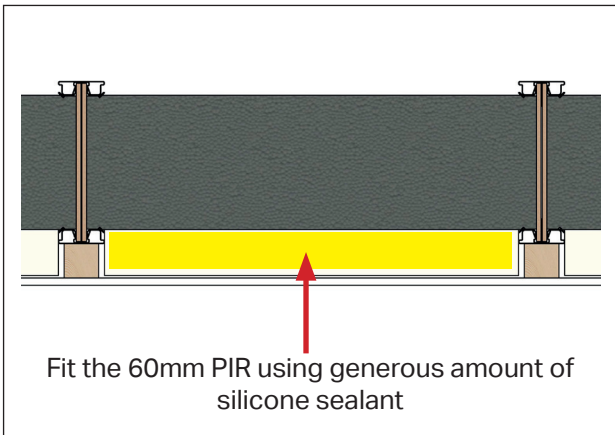
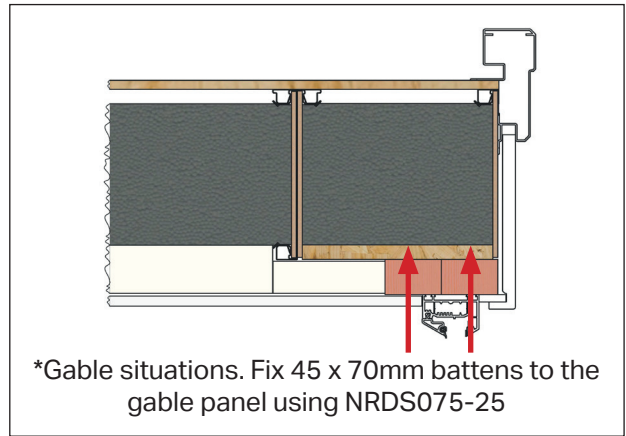
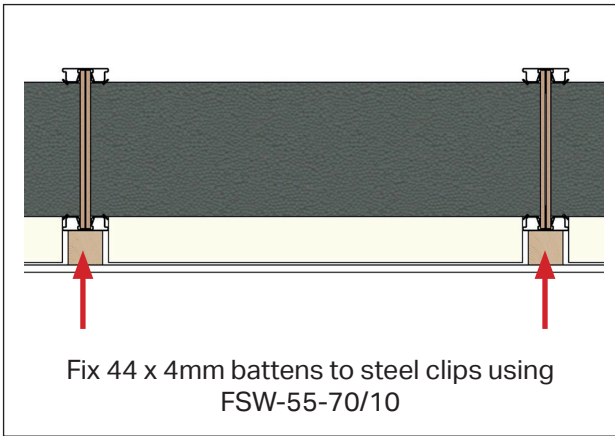
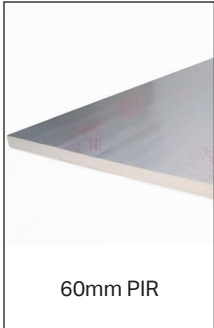

Foil backed plasterboard may then be fitted to the timber battens in the normal way.

# Plasterline Guidance

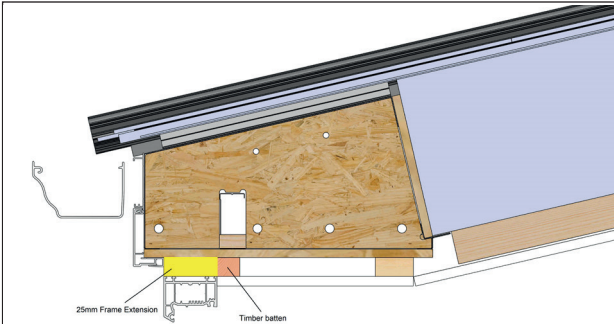

This image is the plaster line detail when at 12.5° using 25mm frame extensions.

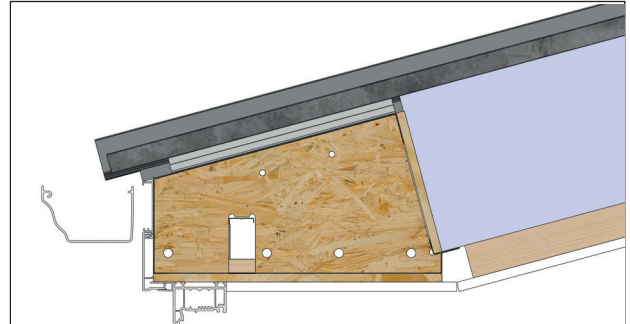

This image is the plaster line detail when at 15°

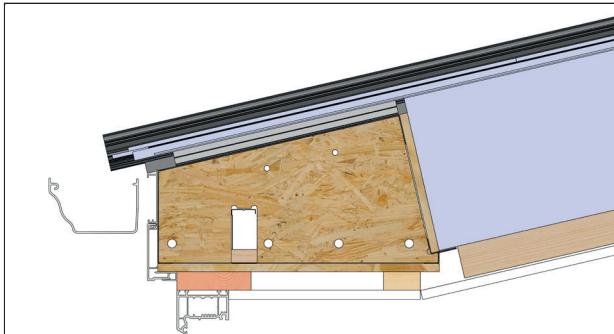

This image is showing the plaster line at 12.5° to 15° using 100 x 25mm timber packer (not supplied)

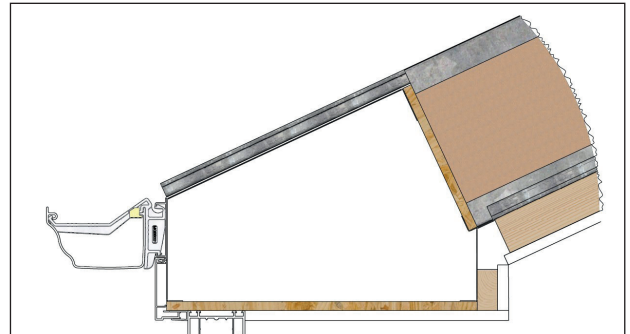

This image is the plaster line detail when at 25°

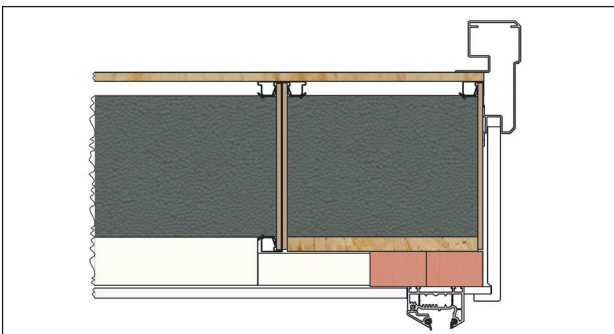

This image is showing the plaster line detail for a standard gable front. 44 x 70mm timber required above the gable frame.

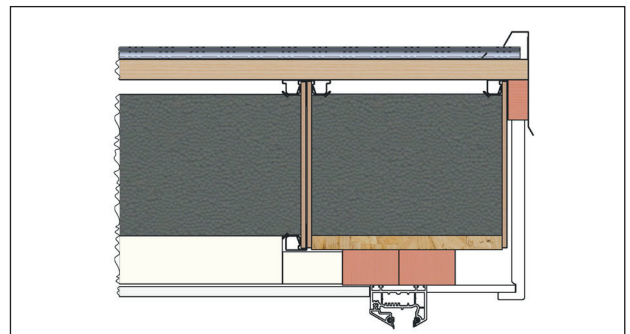

This image is showing the plaster line detail for an extended gable front. 44 x 70mm timber required above the gable frame.

Please contact the Tech Support Team on 01200 452 918 or email [techsupport@ultraframe.co.uk](mailto:techsupport@ultraframe.co.uk)

For everything you need to know about Ultrarroof including guides and installation videos visit [ur380info.co.uk](http://ur380info.co.uk) or scan the QR Code



  
**Ultrarroof**<sup>®</sup>  
By Ultraframe